



Workbook. **2023-2024**

second edition november

## GENERAL INFORMATION

Our production started off and continues to be of an artisanal nature. Our lamps are not produced in large series, from moulds or sophisticated plants but they are hand-crafted by our artisans. Slight flaws are thus not to be considered defects, but rather the typical characteristics of manual work.

Catellani & Smith declares under its own responsibility that its products meet the essential requirements of EC directives and comply with EN 60598 for luminaires and related components. Catellani & Smith lamps are built with a voltage of 220/240V.

The pricelist specifies which luminaires are compatible with a voltage of 110V (with standard EC components and not with UL certified components) and which ones can be compatible upon request, by making some styling and technical modifications (price estimate to be provided).

Production is tested 100%: each product undergoes a thorough quality control that guarantees it is intact and fully functional. The guarantee covers the item for 2 years from the date of purchase, including the right to a replacement or to the repair of the product or parts thereof affected by manufacturing defects detected at the time of purchase or that arise over the next two years. **The guarantee does not cover any damage to luminaires caused by connection to incompatible dimmers or control and dimming systems.** Compatibility of our products with dimmers or home automation systems must be checked prior to purchase and it is the responsibility of the customer or person acting for him/her.

The guarantee does not include any refunds for the intervention of qualified staff (electrician, etc.) or costs for the installation/disassembly or costs related to equipment (such as scaffolding access platforms, scaffolding, etc.) required to access the luminaires and perform maintenance and control operations on them.

It is advisable always to test the luminaires on the ground before final installation if they are to be fitted under special circumstances or connected to control and dimming systems.

In compliance with the regulations in force, **the manufacturer reserves the right to make any styling or technical changes without prior notice.**

**Such changes also include the type and wattage of light bulbs and electronic parts.** These changes are due to market availability issues since it is continuously growing and evolving, and it tends to eliminate certain products in favour of others, discontinuing their production without notice (which is increasingly often the case with LED bulbs).

According to regulation 2017/1369, starting from 01/03/2022 the new energy efficiency classification comes into force, which also concerns light sources.

The rating scale goes from A (maximum efficiency) to G (minimum efficiency), replacing the previous scale from A +++ to D, as required by Directive 2010/30 / EU currently in force.

Based on warehouse supplies, we will update the indication of the energy class in our documentation.

In our website we will also provide the link to access all information concerning the light sources supplied: some datas (such as lumen or wattage) might vary from what mentioned in the workbook, as they are measured on the pure sources, not on our appliances.

The Catellani & Smith Workbook is designed to help and protect the customer in his/her choice of products. We therefore recommend that you read each section thoroughly, given the complexity of the electronic parts, and that you check the compatibility between the various components (such as dimmers, light sources, etc.) and contact qualified staff for the choice and installation of products.



Latest Creations

p. 6



Enso Syphaspot Chandelier Syphaspot JC/IC

Colore

p. 6



Ettorino T Ettorino Clamp Ettorino F Ettorino BIG Ale BE T

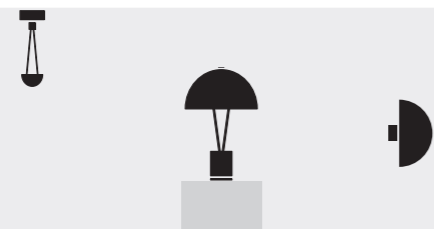

Ale C Ale BIG Ale W

SimilDesign

p. 12



Sfera W Cono W Atman



28 Petits Bijoux 56 Petits Bijoux 22 Petites Lentilles

Lederam

p. 16



Lederam Manta S1 Lederam Manta S2 Lederam C150/180 Lederam Manta CWS1 Lederam C2 Lederam W



Lederam W1 Lederam W2 Lederam WF Lederam T1 Lederam F0 Lederam F1



Lederam F2 Lederam F3

Sorry Giotto

p. 26

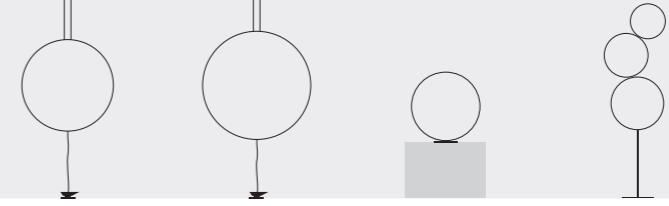

Sorry Giotto 9 Sorry Giotto 12 Sorry Giotto 1 Sorry Giotto 3

Light Stick

p. 28

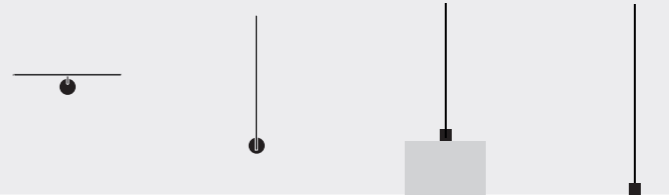

Light Stick CW Light Stick V Light Stick T Light Stick F

Wa Wa

p. 30

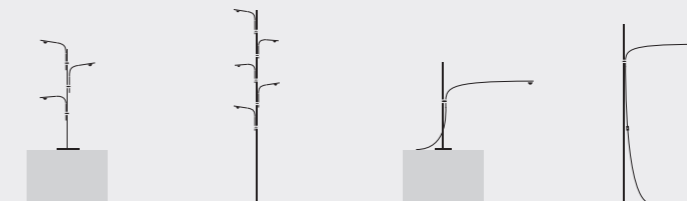

Wa Wa T Wa Wa F Uau T Uau F

Giulietta

p. 32

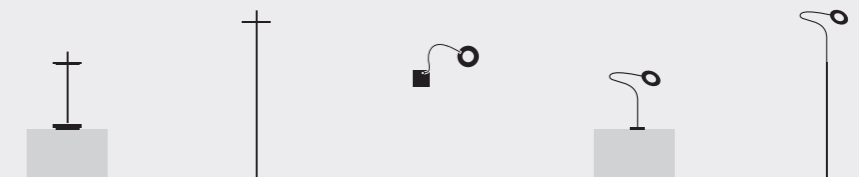

Giulietta BE T Giulietta BE F Giulietta W Giulietta T Giulietta F

Jackie O

p. 36

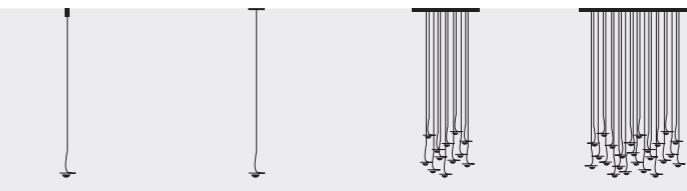

Jackie O JC Jackie O IC Jackie O Chand. 6/9/12 Jackie O Chand. 15/20/24

PostKrisi

p. 38



PostKrisi 50-51-52 PostKrisi 10 Malagolina PostKrisi F 100 PostKrisi W 21-40 PostKrisi CW 70 PostKrisi 49

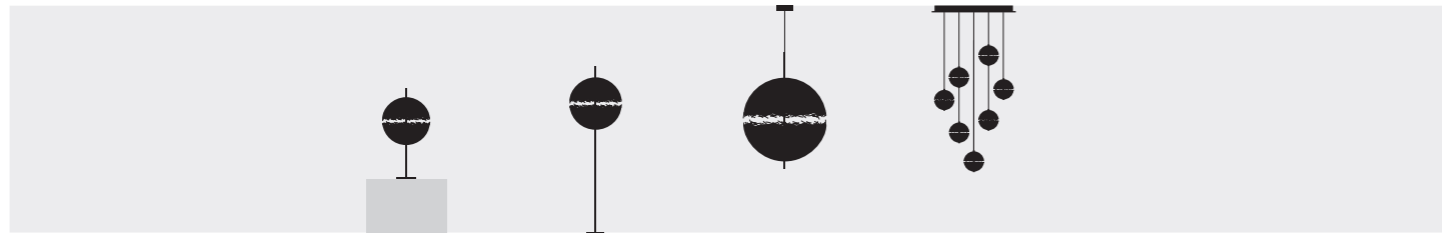

PostKrisi T 61    PostKrisi F 64    PostKrisi 65-66-67    PostKrisi Chandelier

### Fil de Fer

p. 46

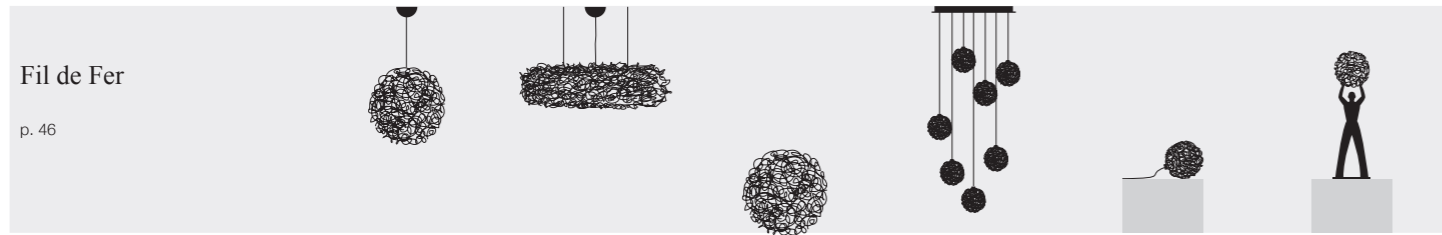

Fil de Fer    Fil de Fer Nuvola    Fil de Fer F    Sweet Light Chandelier    Sweet Light T    Uomo della Luce S

### Lucenera

p. 50

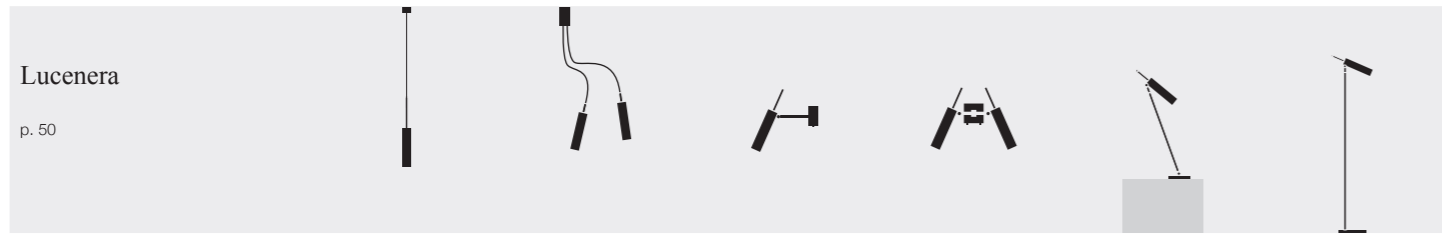

Lucenera 504    Lucenera 206    Lucenera 502    Lucenera 503    Lucenera 500    Lucenera 506

### Stchu-Moon

p. 52



Stchu-Moon 02    Stchu-Moon 02 230V    Stchu-Moon 02 Chand.    Stchu-Moon 05    Stchu-Moon 08    Stchu-Moon R

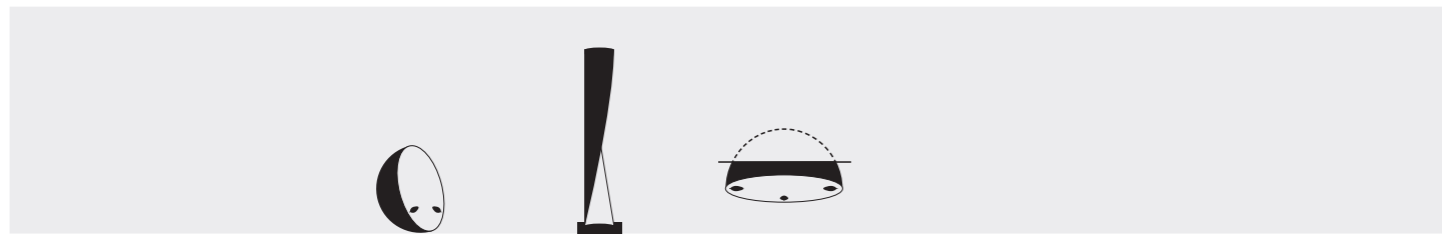

Stchu-Moon 01    Stchu-Moon 09    Stchu-Moon SR

### Macchina della Luce

p. 58

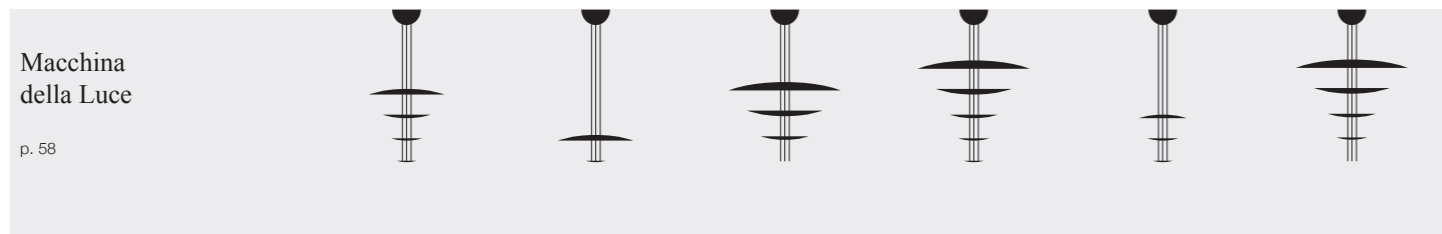

mod. A    mod. B    mod. C    mod. D    mod. E    mod. F

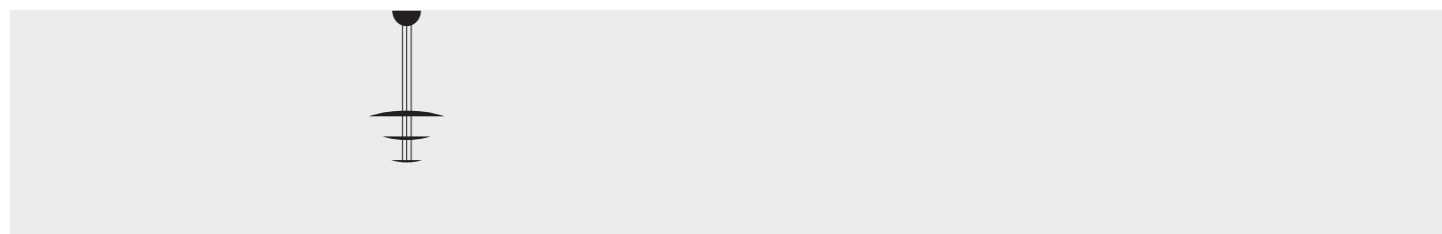

mod. I

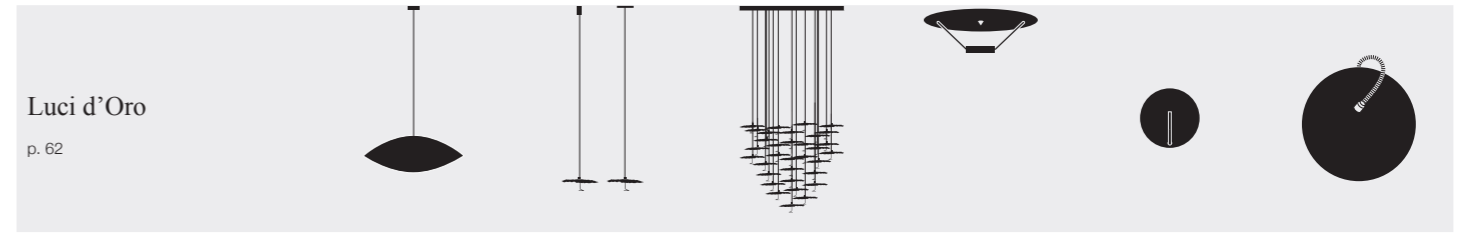

Luci d'Oro  
p. 62

Malagola 27/55/110    Gold Moon JC/IC    Gold Moon Chandelier    DiscO    Luna W    Luna Piena

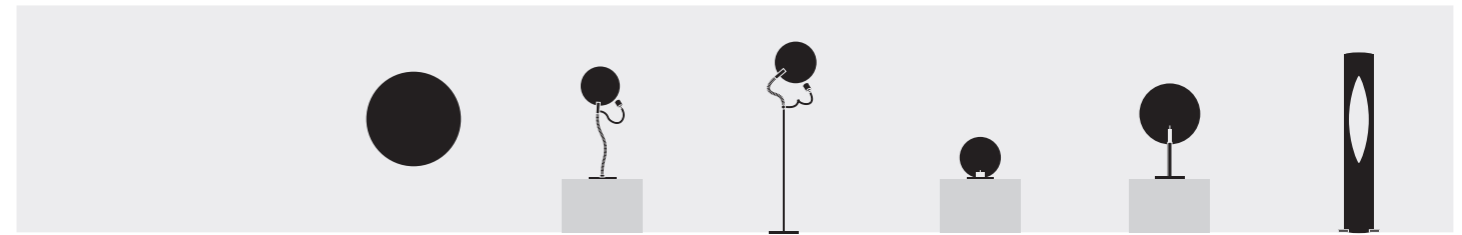

Francesca    Luce d'Oro T    Luce d'Oro F    Luna    Gemma    Colonna

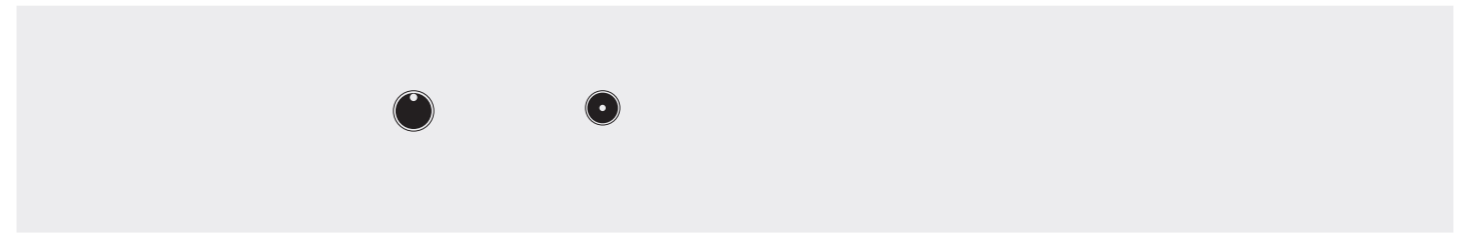

Pepita 102    Pepita 65

### Turciù

p. 72

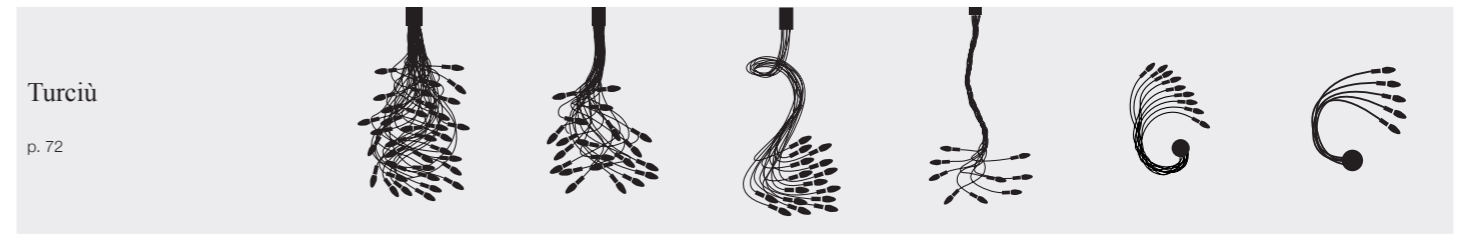

Turciù 36    Turciù 21    Turciù 16    Turciù 9    Turciù 9    Turciù 5

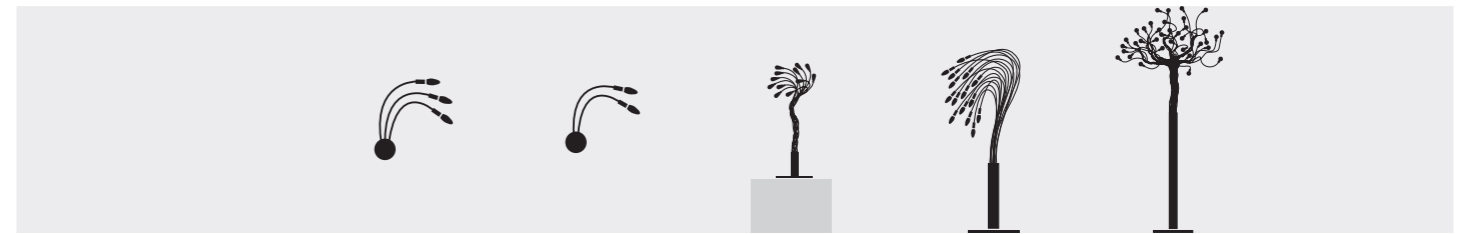

Turciù 3    Turciù 2    Bonsai    Sottovento 15    Albero della Luce

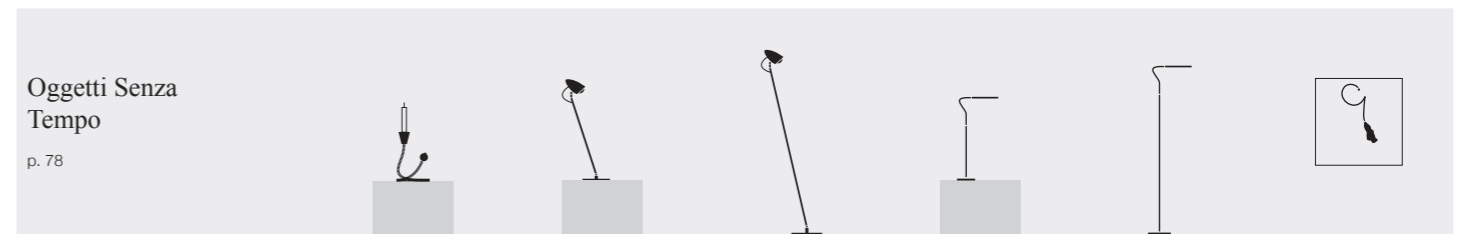

Oggetti Senza Tempo  
p. 78

Miracolo    Ciclotalia T    Ciclotalia F    Lola T    Lola F    Luce che dipinge

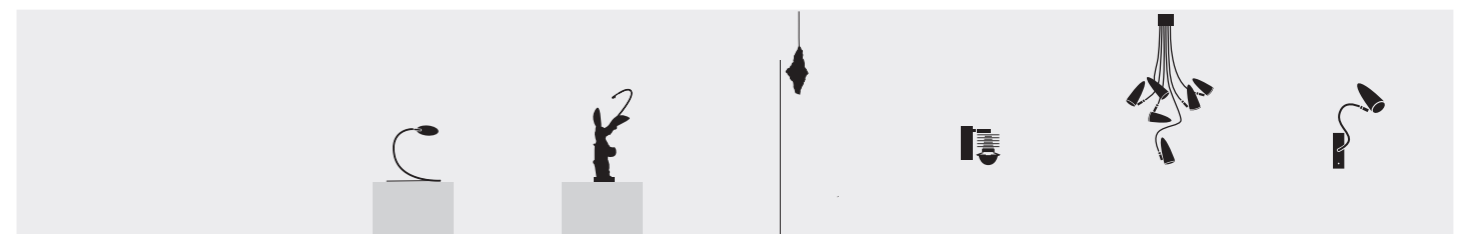

Herem T    Nike    Shadow    EC 301    Ciclotalia Flex C6    Ciclotalia Flex W1



Ciclotalia Flex W2



Ciclotalia Flex F3



U. W



U. F Up



U. W Flex



U. F Flex



Vi. W



Vi. F

### Other Smiths

p. 88



Talismano (Other Smiths)



Alchemie T

### Medousê (outdoor)

p. 90



Medousê W



Medousê F

### More (outdoor)

p. 92



More



More 0

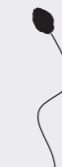

More F

### Sypha

p. 94



Syphasera



Syphasera



Syphaduepassi

### Fil de Fer

p. 96



Fil de Fer



Fil de Fer F



Uomo della Luce XXL



### Limited Edition

p. 98



Trenta

### Technical information

p. 100

Lederam: colour combinations and details

p. 101

Outdoor accessories

p. 112

Mains voltage LED

p. 104

Medousê installation suggestions

p. 113

Chandelier

p. 106

Installation suggestions for Sypha/More

p. 114

Macchina della Luce LED boards

p. 108

PSU (Power Supply Unit) Kits for 24V DC JC/IC pendants

p. 116

Stchu-Moon LED boards

p. 109

Drivers @24V DC

p. 117

Outdoor: Gel box system

p. 110

Instructions for the connection of multiple recessed lamps

p. 118

Outdoor: Quick connectors system

p. 111

Dimming wiring diagrams

p. 119

Outdoor: Fil de Fer

p. 111

## Latest creations

[ Finishes ] // **Untreated brass** (an alloy of copper and zinc) is a very elegant finish, yellow-gold in colour, with an excellent corrosion resistance. We use it untreated, therefore it may oxidise with time. Regular cleaning helps preserving its original appearance and slow down the ageing process, which might be anyway accelerated by the weather, frequent handling or conditions of high humidity. / **Hand painting** is chosen for its deliberate textured effect and uniqueness of result. Any irregularities or unevenness in the coating cannot be considered defect, but rather a hallmark of the artisanal crafting process. / **Satin Steel** - the standard modular metal bases are composed of a satin steel plate mounted on a white lacquered metal frame and fixed to it by nickel square-head screws. On request we can supply the plate white matt lacquered as the frame or in different RAL colours.

[ Note ] // The **lumen** value refers to the rated lumen output of the light source; for the lamp's output please refer to our bim files (see website). / ( \* ) The plug driver 110-240V is supplied with the electrical plug suitable for the market of reference only. Please specify in stage of order if the destination of the product differs from your standard. / ( \*\* ) Our LEDs can be dimmed by using compatible dimmers tested specifically to dim very low loads. We suggest checking the minimum load of the dimmer before installation.

p. 17

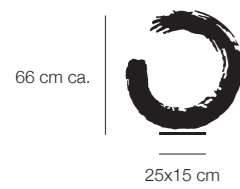

### Enso / table lamp

ENSO / blue / brass base / black dimmer and wire

€ 2.995,00

voltage	source	type	watt	lumen	K	CRI	en. class	driver/transformer	dimmer
110-240V	constant current LED	LED board	11x1W 11W	1749	2700	>90	F	plug driver*	included (memory last step)

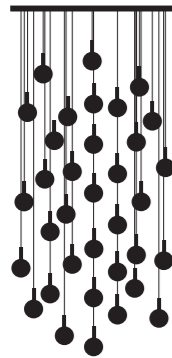

### Syphaspot Chandelier / pendant lamp

CSYFSPL20C / satin steel base / 20x glass sphere with black/brass support / nickel jack / black wires € 6.500,00

CSYFSPL25C / satin steel base / 25x glass sphere with black/brass support / nickel jack / black wires € 8.125,00

CSYFSPL35C / satin steel base / 35x glass sphere with black/brass support / nickel jack / black wires € 11.375,00

voltage	source	type	watt	lumen	K	CRI	en. class	driver/transformer	dimming
110V or 240V	constant voltage 24V LED	LED jack/interch.	20x1,2W 24W	3200	2700	>90	F	constant voltage driver	YES IGBT/Triac**
			25x1,2W 30W	4000					
			35x1,2W 42W	5600					

base Ø 78 cm / shades Ø 10 cm /  
H max 300 cm not adjustable

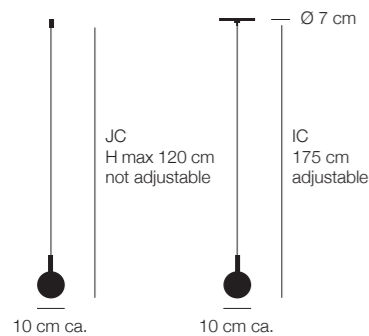

### Syphaspot JC / IC / recessed/pendant lamp for plasterboard ceiling

SYFSPLJC / mod. JC / nickel jack connection / black wire / glass sphere with black/brass support € 290,00

SYFSPLIC / mod. IC / nickel plate with tensioner / black wire / glass sphere with black/brass support € 280,00

voltage	source	type	watt	lumen	K	CRI	en. class	driver/transformer	dimming
-	constant voltage 24V LED	LED jack/interch. interch. LED	1x1,2W	160	2700	>90	F	not included available on request	-

installation hole mod. JC Ø 1,25 cm  
installation hole mod. IC Ø 5,5 cm  
max plasterboard thickness 12,5 mm

## Colore

[ Finishes ] // **Untreated brass** (an alloy of copper and zinc) is a very elegant finish, yellow-gold in colour, with an excellent corrosion resistance. We use it untreated, therefore it may oxidise with time. Regular cleaning helps preserving its original appearance and slow down the ageing process, which might be anyway accelerated by the weather, frequent handling or conditions of high humidity.

[ Note ] // The **lumen** value refers to the rated lumen output of the light source; for the lamp's output please refer to our bim files (see website). / ( \* ) The plug driver 110-240V is supplied with the electrical plug suitable for the market of reference only. Please specify in stage of order if the destination of the product differs from your standard.

p. 23

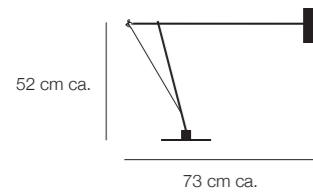

### Ettorino T / table lamp

		voltage	source	type	watt	lumen	K	CRI	en. class	driver/transformer	dimmer
ETRT / colourful (white/red/yellow/blue) / red man silhouette / nickel dimmer / blue wire	€ 1.650,00	110-240V	constant current LED 300 mA	COB LED	10W	1441	2700	>80	E	plug driver*	included (memory last step)
ETRTB / black / red man silhouette / nickel dimmer / black wire	€ 1.550,00										
ETRTW / white / red man silhouette / nickel dimmer / blue wire	€ 1.550,00										

p. 27

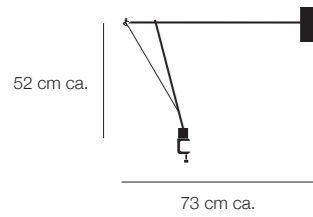

### Ettorino Clamp / table lamp with clamp

		voltage	source	type	watt	lumen	K	CRI	en. class	driver/transformer	dimmer
ETRC / colourful (white/red/yellow/blue) / red man silhouette / nickel dimmer / blue wire	€ 1.700,00	110-240V	constant current LED 300 mA	COB LED	10W	1441	2700	>80	E	plug driver*	included (memory last step)
ETRCB / black / red man silhouette / nickel dimmer / black wire	€ 1.600,00										
ETRCW / white / red man silhouette / nickel dimmer / blue wire	€ 1.600,00										

p. 31

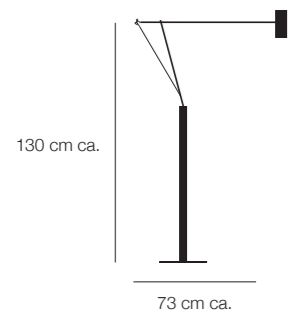

### Ettorino F / standing lamp

		voltage	source	type	watt	lumen	K	CRI	en. class	driver/transformer	dimmer
ETRF / colourful (white/red/yellow/blue) / red man silhouette / blue wire	€ 1.950,00	110-240V	constant current LED 300 mA	COB LED	10W	1441	2700	>80	E	plug driver*	push dimmer
ETRFB / black / red man silhouette / black wire	€ 1.850,00										
ETRFW / white / red man silhouette / blue wire	€ 1.850,00										

p. 35

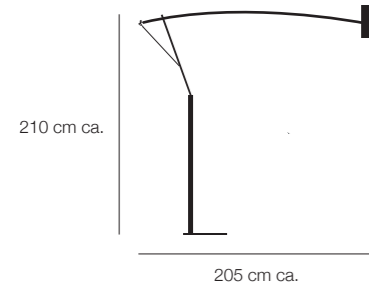

**Ettoreino BIG /** standing lamp

ETRBIG / colourful (white/red/yellow/blue) / red man silhouette / black wire	€	4.850,00
ETRBIGB / black / red man silhouette / black wire	€	4.550,00
ETRBIGW / white / red man silhouette / black wire	€	4.550,00

voltage	source	type	watt	lumen	K	CRI	en. class	driver/transformer	dimming
110-240V	constant current LED 450 mA	COB LED	15W	2187	2700	>80	D	plug driver*	push dimmer (downwards)
	constant current LED 350 mA	interch. LED	1W	149	2700	85	D		on/off (upwards)

p. 41

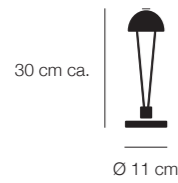

**Ale BE T /** battery table lamp

ALEBT / colourful (white/red/yellow/blue) / black fly	€	800,00
ALEBTFL / fluo (orange/blue/yellow/magenta) / black fly	€	800,00
ALEBTB / black / white fly	€	700,00
ALEBTW / white / black fly	€	700,00

battery	source	type	watt	lumen	K	CRI	en. class	battery charger	dimmer
Li-ION 3,7V 4100 mAh	constant voltage LED	LED board	1,5W	219	2700	>80	D	input 110/240V output 5V@1,2 A (EU or UK plug only)	on/off switch

p. 45



**Ale C /** ceiling lamp

ALEC / colourful (white/red/yellow/blue)	€	650,00
ALECFL / fluo (orange/blue/yellow/magenta)	€	650,00
ALECB / black	€	550,00
ALECW / white	€	550,00

voltage	source	type	watt	lumen	K	CRI	en. class	driver/transformer	dimming
240V (110V available on request)	constant current LED 270 mA	COB LED	9W	1296	2700	>80	E	constant current driver	IGBT/Triac dimmable

p. 49

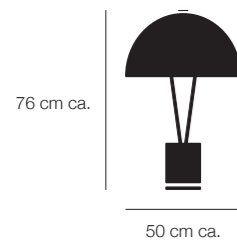

**Ale BIG /** table lamp

ALEBIG / colourful (white/red/yellow/blue) / black fly and wire	€	3.600,00
ALEBIGFL / fluo (orange/yellow/magenta) / black fly and wire	€	3.600,00
ALEBIGB / black / white fly / black wire	€	3.450,00
ALEBIGW / white / black fly and wire	€	3.450,00

voltage	source	type	watt	lumen	K	CRI	en. class	driver/transformer	dimmer
110-240V	constant current LED	COB LED	15W	2187	2700	>80	D	plug driver*	push dimmer



p. 55

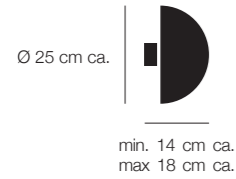

**Ale W** / wall lamp

		voltage	source	type	watt	lumen	K	CRI	en. class	driver/transformer	dimming
ALEW / colourful (white base / blue shade) / black fly	€ 850,00	240V (110V available on request)	constant current LED 500 mA	LED board	13W	2019	2700	90	F	constant current driver	IGBT/Triac dimmable
ALEWFL / fluo (white base / magenta shade) / black fly	€ 850,00										
ALEWB / black (white base / black shade) / white fly	€ 750,00										
ALEWW / white (white base and shade) / black fly	€ 750,00										

**SimilDesign**

[ *Finishes* ] // **Hand painting** is chosen for its deliberate textured effect and uniqueness of result. Any irregularities or unevenness in the coating cannot be considered defect, but rather a hallmark of the artisanal crafting process. / **Nickel coating** (metal plating process) is chosen by the designer for its elegant and warm finish. To prevent any natural oxidation process, it requires regular cleaning. In alternative to nickel coating, customized finishes (i.e. chrome plating) can be provided upon request.

[ *Note* ] // The **lumen** value refers to the rated lumen output of the light source; for the lamp's output please refer to our bim files (see website). / ( **\*** ) The plug driver 110-240V is supplied with the electrical plug suitable for the market of reference only. Please specify in stage of order if the destination of the product differs from your standard. / ( **\*\*** ) 220-240V version available with not interchangeable EU plug only - memory 100%.

p. 61



**Sfera** / wall lamp

		voltage	source	type	watt	lumen	K	CRI	en. class	driver/transformer	dimming
SFWNC / nickel mirrored	€ 1.195,00	240V (110V available on request)	constant current LED 450 mA	COB LED	15W	2187	2700	80	D	constant current driver	IGBT/Triac dimmable

p. 65

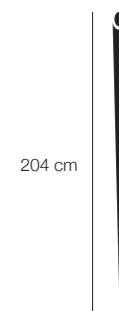

**Cono** / wall lamp with floor connection

		voltage	source	type	watt	lumen	K	CRI	en. class	driver/transformer	dimming
CNW / blue/internal irregular with gold coloured leaf / black wire	€ 2.750,00	110-240V	constant current LED 450 mA	COB LED	15W	2187	2700	80	D	plug driver*	push dimmer (upwards)
			12V DC LED bulb	G4 bulb	0,8W	67	2700	80	F		on/off (downwards)

p. 66

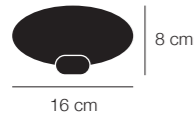

**Atman / table lamp**

AT / oval crystal glass / nickel base / blue wire / black dimmer

€ 1.375,00

voltage	source	type	watt	lumen	K	CRI	en. class	driver/transformer	dimmer
110-240V**	constant current LED 350 mA	interch. LED	1x1W	149	2700	85	D	plug driver***	included (memory last step)

## Les Petites

[ *Finishes* ] // **Untreated brass** (an alloy of copper and zinc) is a very elegant finish, yellow-gold in colour, with an excellent corrosion resistance. We use it untreated, therefore it may oxidise with time. Regular cleaning helps preserving its original appearance and slow down the ageing process, which might be anyway accelerated by the weather, frequent handling or conditions of high humidity.

[ *Note* ] // The **lumen** value refers to the rated lumen output of the light source; for the lamp's output please refer to our bim files (see website). / ( **\*\*** ) The remote control provided allows to switch on and dim independently the LED strip on the base and the LEDs on the oval. The system (we use Casambi) can be programmed and controlled also via app. / ( **\*\*\*** ) Our LEDs can be dimmed by using compatible dimmers tested specifically to dim very low loads. We suggest checking the minimum load of the dimmer before installation.

p. 74

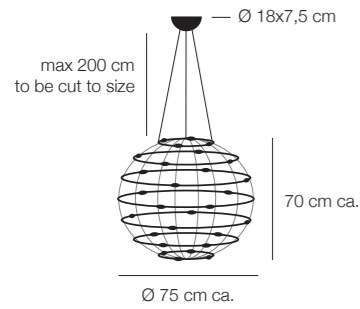

**28 Petits Bijoux / pendant lamp**

PB28 / untreated brass rings / white base / transparent covers with brass clips

€ 5.650,00

voltage	source	type	watt	lumen	K	CRI	en. class	driver/transformer	dimming
110V* or 240V	constant voltage 24V LED	interch. LED board	28x1,1W 30,8W	1764	2700	90	G	constant voltage driver	YES IGBT/Triac***

\*110V version available with white base Ø 21x10,5 cm

weight 6 kg

p. 77

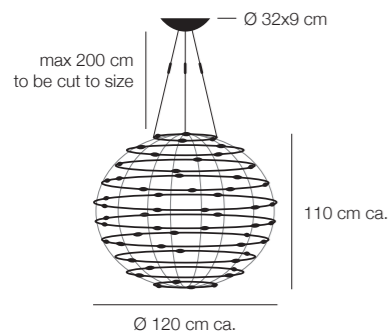

**56 Petits Bijoux / pendant lamp**

PB56 / untreated brass rings / white base / transparent covers with brass clips

€ 8.755,00

voltage	source	type	watt	lumen	K	CRI	en. class	driver/transformer	dimming
110V or 240V	constant voltage 24V LED	interch. LED board	56x1,1W 61,6W	3528	2700	90	G	constant voltage driver	YES IGBT/Triac***

weight 13 kg

p. 83

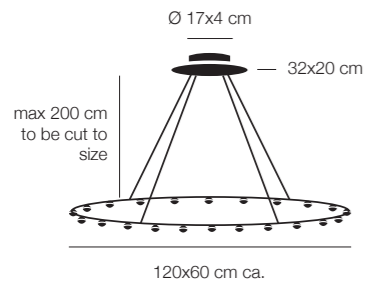

22 Petites Lentilles / pendant lamp

PL22 / untreated brass oval / white base / transparent lens with brass holder

€ 4.405,00

voltage	source	type	watt	lumen	K	CRI	en. class	driver/transformer	dimming
110V or 240V	constant voltage 24V LED	interch. LED board	22x1,1W 24,2W	1386	2700	90	G	constant voltage driver	wireless independent (remote control included)**
		low voltage LED strip (directed upwards)	4W	150	3000	80			

weight 3,6 kg

Lederam

[ Note ] // The **lumen** value refers to the rated lumen output of the light source; for the lamp's output please refer to our bim files (see website). / ( \* ) Mains voltage LED modules and COB LED are dimmable using IGBT (trailing edge) dimmers designed specifically for LED sources. Their dimming is extremely delicate: incompatible dimmers may cause irreparable damage to the LED. Some dimmers on the market have a NO button (Normally Open) or are specific connector socket-mounted or recessed. They are generally inserted into junction boxes; their limited thickness facilitates the installer's task and makes the dimmer fit for installation even in shallow boxes. Dimmers with an integrated radio dimmer for both manual (NO button) and wireless control are also available. It is important to note that during adjustment the dimming appears less precise, with some flickering. Furthermore some types of dimmer, even if they have been recommended by the manufacturers themselves, have visible flickering (almost essentially down to a minimum) depending on the mains and on the type of interference present. The problem can be solved by increasing the minimum value setting of the potentiometer on the dimmer. Low voltage DALI or 1...10V versions available on request. / ( \*\* ) The plug driver 110-240V is supplied with the electrical plug suitable for the market of reference only. Please specify in stage of order if the destination of the product differs from your standard.

p. 88

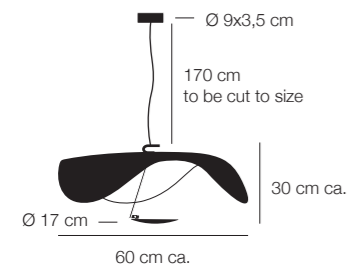

Lederam Manta S1 / pendant lamp

LS13 / shade black/gold / black rod / gold disc / black base

€ 910,00

LS14 / shade black/copper / black rod / copper disc / black base

€ 910,00

LS15 / shade white/white / gold rod / white disc / white base

€ 810,00

LS16 / shade white/gold / satin rod / white disc / white base

€ 910,00

LS18 / shade white/white / satin rod / white disc / white base

€ 810,00

LS110 / shade white/white / white rod / white disc / white base

€ 810,00

voltage	source	type	watt	lumen	K	CRI	en. class	driver/transformer	dimming
240V	mains voltage LED	LED module	1x15W	1550	2700	80	F		YES*
		(LED module)	(1x14W)	(1540)	(2700)	(80)	(A+)		(YES*)

weight 2 kg

p. 89

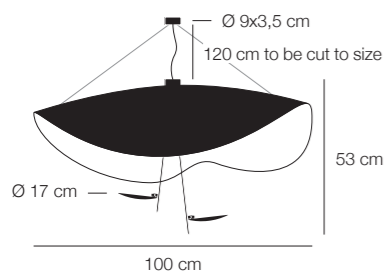

Lederam Manta S2 / pendant lamp

LS23 / shade black/gold / black rods / gold discs / black bases

€ 2.155,00

LS24 / shade black/copper / black rods / copper discs / black bases

€ 2.155,00

LS25 / shade white/white / gold rods / white discs / white bases

€ 2.005,00

LS26 / shade white/gold / satin rods / white discs / white bases

€ 2.155,00

LS28 / shade white/white / satin rods / white discs / white bases

€ 2.005,00

voltage	source	type	watt	lumen	K	CRI	en. class	driver/transformer	dimming
240V	mains voltage LED	LED module	2x15W 30W	3100	2700	80	F		YES*
		(LED module)	(2x14W 28W)	(3080)	(2700)	(80)	(A+)		(YES*)

weight 5,5 kg

p. 93

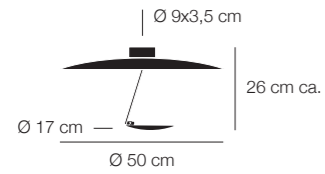

**Lederam C150 / ceiling lamp**

	voltage	source	type	watt	lumen	K	CRI	en. class	driver/transformer	dimming
LC1503 / shade black/gold / black rod / gold disc / black base	240V	mains voltage LED	LED module	1x15W	1550	2700	80	F		YES*
LC1504 / shade black/copper / black rod / copper disc / black base										
LC1505 / shade white/white / gold rod / white disc / white base	(110V)	(mains voltage LED)	(LED module)	(1x14W)	(1540)	(2700)	(80)	(A+)		(YES*)
LC1506 / shade white/gold / satin rod / white disc / white base										
LC1508 / shade white/white / satin rod / white disc / white base										
LC15010 / shade white/white / white rod / white disc / white base										

p. 93

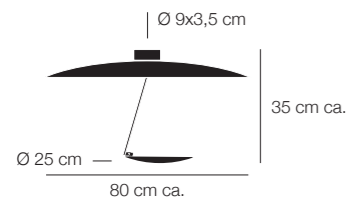

**Lederam C180 / ceiling lamp**

	voltage	source	type	watt	lumen	K	CRI	en. class	driver/transformer	dimming
LC1803 / shade black/gold / black rod / gold disc / black base	240V	mains voltage LED	LED module	1x25W	2875	2700	90	E		YES*
LC1804 / shade black/copper / black rod / copper disc / black base										
LC1805 / shade white/white / gold rod / white disc / white base	(110V)	(mains voltage LED)	(COB LED)	(1x30W)	(2190)	(2700)	(90)	(A+)		(YES*)
LC1806 / shade white/gold / satin rod / white disc / white base										
LC1808 / shade white/white / satin rod / white disc / white base										
LC18010 / shade white/white / white rod / white disc / white base										

p. 96

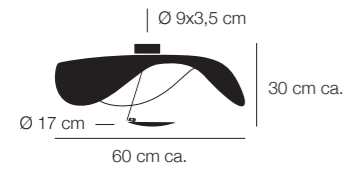

**Lederam Manta CWS1 / ceiling or wall lamp**

	voltage	source	type	watt	lumen	K	CRI	en. class	driver/transformer	dimming
LCWS13 / shade black/gold / black rod / gold disc / black base	240V	mains voltage LED	LED module	1x15W	1550	2700	80	F		YES*
LCWS14 / shade black/copper / black rod / copper disc / black base										
LCWS15 / shade white/white / gold rod / white disc / white base	(110V)	(mains voltage LED)	(LED module)	(1x14W)	(1540)	(2700)	(80)	(A+)		(YES*)
LCWS16 / shade white/gold / satin rod / white disc / white base										
LCWS18 / shade white/white / satin rod / white disc / white base										
LCWS110 / shade white/white / white rod / white disc / white base										

p. 97

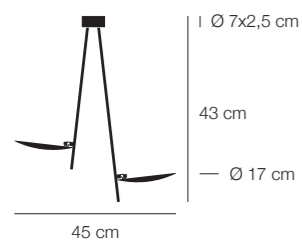

**Lederam C2 / ceiling lamp**

	voltage	source	type	watt	lumen	K	CRI	en. class	driver/transformer	dimming
LC22 / black discs / satin rods / black base	240V	mains voltage LED	LED module	2x15W 30W	3100	2700	80	F		YES*
LC23 / gold discs / black rods / black base										
LC24 / copper discs / black rods / black base	(110V)	(mains voltage LED)	(LED module)	(2x14W 28W)	(3080)	(2700)	(80)	(A+)		(YES*)
LC25 / white discs / gold rods / white base										
LC26 / white discs / satin rods / white base										

p. 99

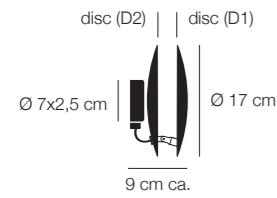

**Lederam W 17 / wall lamp**

	voltage	source	type	watt	lumen	K	CRI	en. class	driver/transformer	dimming
LW171 / disc D1 black/copper - disc D2 copper/black / black base	240V	mains voltage LED	LED module	1x15W	1550	2700	80	F	-	YES*
LW172 / disc D1 black/gold - disc D2 gold/black / black base										
LW173 / disc D1 gold/gold - disc D2 gold/white / white base	(110V)	(mains voltage LED)	(LED module)	(1x14W)	(1540)	(2700)	(80)	(A+)	-	(YES*)
LW174 / disc D1 copper/copper - disc D2 copper/white / white base										
LW175 / disc D1 white/gold - disc D2 gold/white / white base										
LW176 / disc D1 white/copper - disc D2 copper/white / white base										

p. 99

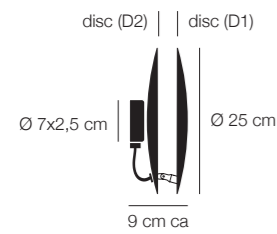

**Lederam W 25 / wall lamp**

	voltage	source	type	watt	lumen	K	CRI	en. class	driver/transformer	dimming
LW251 / disc D1 black/copper - disc D2 copper/black / black base	240V	mains voltage LED	LED module	1x15W	1550	2700	80	F	-	YES*
LW252 / disc D1 black/gold - disc D2 gold/black / black base										
LW253 / disc D1 gold/gold - disc D2 gold/white / white base	(110V)	(mains voltage LED)	(LED module)	(1x14W)	(1540)	(2700)	(80)	(A+)	-	(YES*)
LW254 / disc D1 copper/copper - disc D2 copper/white / white base										
LW255 / disc D1 white/gold - disc D2 gold/white / white base										
LW256 / disc D1 white/copper - disc D2 copper/white / white base										

p. 132

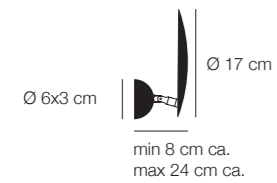

**Lederam W1 17 / wall lamp**

	voltage	source	type	watt	lumen	K	CRI	en. class	driver/transformer	dimming
LW1171 / black disc / black base	240V	mains voltage LED	LED module	1x15W	1550	2700	80	F	-	YES*
LW1173 / gold/black disc / black base										
LW1174 / copper/black disc / black base	(110V)	(mains voltage LED)	(LED module)	(1x14W)	(1540)	(2700)	(80)	(A+)	-	(YES*)
LW1176 / white disc / white base										

p. 100

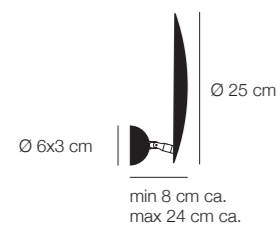

**Lederam W1 25 / wall lamp**

	voltage	source	type	watt	lumen	K	CRI	en. class	driver/transformer	dimming
LW1251 / disc Ø 25 cm black / black base	240V	mains voltage LED	LED module	1x15W	1550	2700	80	F	-	YES*
LW1253 / disc Ø 25 cm gold/black / black base										
LW1254 / disc Ø 25 cm copper/black / black base	(110V)	(mains voltage LED)	(LED module)	(1x14W)	(1540)	(2700)	(80)	(A+)	-	(YES*)
LW1256 / disc Ø 25 cm white / white base										

p. 101

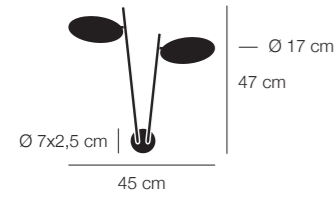

**Lederam W2 / wall lamp**

LW22 / black discs / satin rods / black base	€	750,00
LW23 / gold discs / black rods / black base	€	810,00
LW24 / copper discs / black rods / black base	€	810,00
LW25 / white discs / gold rods / white base	€	750,00
LW26 / white discs / satin rods / white base	€	750,00

voltage	source	type	watt	lumen	K	CRI	en. class	driver/transformer	dimming
240V	mains voltage LED	LED module	2x15W 30W	3100	2700	80	F		YES*
			(110V)	(mains voltage LED)	(LED module)	(2x14W 28W)	(3080)		(2700)

p. 102

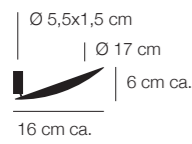

**Lederam WF 17 / wall lamp**

LWF171 / black disc / black base	€	300,00
LWF173 / gold/white disc / white base	€	330,00
LWF174 / copper/white disc / white base	€	330,00
LWF176 / white disc / white base	€	300,00

voltage	source	type	watt	lumen	K	CRI	en. class	driver/transformer	dimming
240V	mains voltage LED	LED module	1x15W	1550	2700	80	F		YES*
			(110V)	(mains voltage LED)	(LED module)	(1x14W)	(1540)		(2700)

p. 102

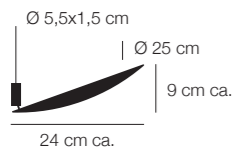

**Lederam WF 25 / wall lamp**

LWF251 / black disc / black base	€	355,00
LWF253 / gold/white disc / white base	€	395,00
LWF254 / copper/white disc / white base	€	395,00
LWF256 / white disc / white base	€	355,00

voltage	source	type	watt	lumen	K	CRI	en. class	driver/transformer	dimming
240V	mains voltage LED	LED module	1x25W	2875	2700	90	E		YES*
			(110V)	(mains voltage LED)	(LED module)	(1x28W)	(2580)		(2700)

p. 103

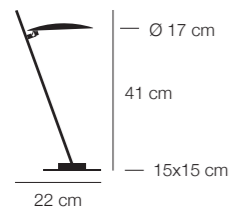

**Lederam T1 / table lamp**

LT12LVO / black disc / satin rod / black base/cable/dimmer	€	610,00
LT13LVO / gold disc / black rod / black base/cable/dimmer	€	640,00
LT14LVO / copper disc / black rod / black base/cable/dimmer	€	640,00
LT15LVO / white disc / gold rod / white base / black dimmer / blue cable	€	610,00
LT16LVO / white disc / satin rod / white base / black dimmer / blue cable	€	610,00

voltage	source	type	watt	lumen	K	CRI	en. class	driver/transformer	dimmer
110-240V	constant current LED 300 mA	COB LED	1x10W	1441	2700	>80	E	plug driver**	included (memory last step)

p. 104

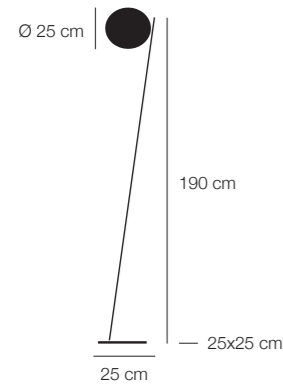

**Lederam F0** / standing lamp

	voltage	source	type	watt	lumen	K	CRI	en. class	driver/transformer	dimmer	
LF012LVO / brass disc / black rod / black base/cable/dimmer	110-240V	constant current LED 500 mA	COB LED	1x17W	2500	2700	>80	D	plug driver**	included (memory last step)	
LF02LVO / black disc / satin rod / black base/cable/dimmer											€ 985,00
LF03LVO / gold disc / black rod / black base/cable/dimmer											€ 1.015,00
LF04LVO / copper disc / black rod / black base/cable/dimmer											€ 1.015,00
LF06LVO / white disc / satin rod / white base / black cable/dimmer											€ 985,00

p. 107

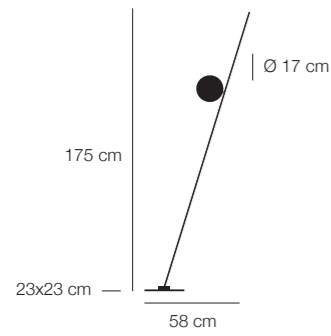

**Lederam F1** / standing lamp

	voltage	source	type	watt	lumen	K	CRI	en. class	driver/transformer	dimmer	
LF12 / black disc / satin rod / black base/cable/dimmer	240V	mains voltage LED	LED module	1x15W	1550	2700	80	F		included (memory last step)	
LF13 / gold disc / black rod / black base/cable/dimmer											€ 905,00
LF14 / copper disc / black rod / black base/cable/dimmer	(110V)	(mains voltage LED)	(LED module)	(1x14W)	(1540)	(2700)	(80)	(A+)		(included (memory last step)	
LF15 / white disc / gold rod / white base/cable/dimmer											€ 875,00
LF16 / white disc / satin rod / white base/cable/dimmer											€ 875,00

p. 108

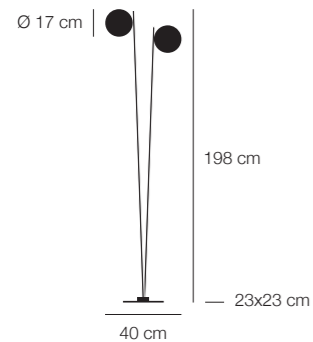

**Lederam F2** / standing lamp

	voltage	source	type	watt	lumen	K	CRI	en. class	driver/transformer	dimmer	
LF22 / black discs / satin rods / black base/cable/dimmer	240V	mains voltage LED	LED module	2x15W 30W	3100	2700	80	F		included (memory last step)	
LF23 / gold discs / black rods / black base/cable/dimmer											€ 1.180,00
LF24 / copper discs / black rods / black base/cable/dimmer	(110V available with on/off)	(mains voltage LED)	(LED module)	(2x14W 28W)	(3080)	(2700)	(80)	(A+)		(included (memory last step)	
LF25 / white discs / gold rods / white base/cable/dimmer											€ 1.120,00
LF26 / white discs / satin rods / white base/cable/dimmer											€ 1.120,00

p. 110

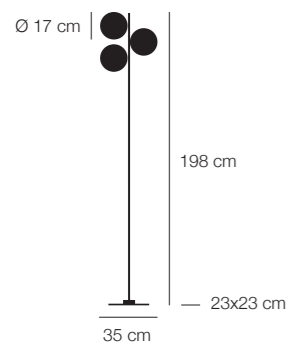

**Lederam F3** / standing lamp

	voltage	source	type	watt	lumen	K	CRI	en. class	driver/transformer	dimmer	
LF32 / black discs / satin rod / black base/cable/dimmer	240V	mains voltage LED	LED module	3x15W 45W	4650	2700	80	F		included (memory last step)	
LF33 / gold discs / black rod / black base/cable/dimmer											€ 1.305,00
LF34 / copper discs / black rod / black base/cable/dimmer	(110V available with on/off)	(mains voltage LED)	(LED module)	(3x14W 42W)	(4620)	(2700)	(80)	(A+)		(included (memory last step)	
LF35 / white discs / gold rod / white base/cable/dimmer											€ 1.215,00
LF36 / white discs / satin rod / white base/cable/dimmer											€ 1.215,00

# Sorry Giotto

[ Finishes ] // **Hand painting** is chosen for its deliberate textured effect and uniqueness of result. Any irregularities or unevenness in the coating cannot be considered defect, but rather a hallmark of the artisanal crafting process. / **Rough iron** (untreated metal) is chosen by the designer specifically because of its uniqueness and its natural ageing property. The appearance of any uneven rust patches does not constitute a defect, since it is a typical sign of the ageing process, which might be considerably accelerated in conditions of high humidity or direct exposure to outdoor weathering.

[ Note ] // The **lumen** value refers to the rated lumen output of the light source; for the lamp's output please refer to our bim files (see website). / ( \* ) The plug driver 110-240V is supplied with the electrical plug suitable for the market of reference only. Please specify in stage of order if the destination of the product differs from your standard. / ( \*\* ) 220-240V version available with not interchangeable EU plug only - memory 100%.

p. 115

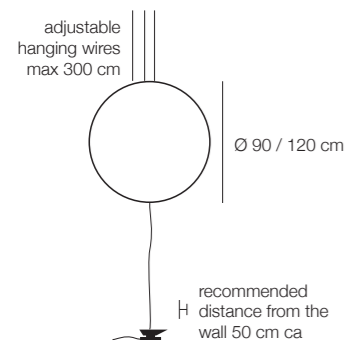

## Sorry Giotto 9 / 12 / pendant lamp with floor connection

		voltage	source	type	watt	lumen	K	CRI	en. class	driver/transformer	dimmer
SG9 / ring Ø 90 cm blue / black anvil / blue wires / black dimmer	€ 2.115,00	110-240V	constant current LED 350 mA	interch. LED	12x1W 12W	1788	2700	85	D	constant current plug driver*	included (memory last step)
SG12 / ring Ø 120 cm blue / black anvil / blue wires / black dimmer	€ 2.905,00				15x1W 15W	2235					

cable from lamp to dimmer 250 cm  
cable from dimmer to plug driver 180 cm

p. 117

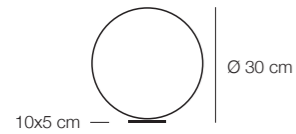

## Sorry Giotto 1 / table lamp

		voltage	source	type	watt	lumen	K	CRI	en. class	driver/transformer	dimmer
SG1 / blue ring / rough iron base / blue wire / black dimmer	€ 835,00	110-240V**	constant current LED 350 mA	interch. LED	4x1W 4W	596	2700	85	D	plug driver***	included (memory last step)

p. 118

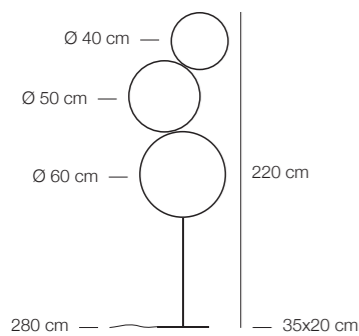

## Sorry Giotto 3 / standing lamp

		voltage	source	type	watt	lumen	K	CRI	en. class	driver/transformer	dimmer
SG3 / blue rings / black base and stem / blue wires / black dimmer	€ 3.130,00	110-240V	constant current LED 350 mA	interch. LED	16x1W 16W	2384	2700	85	D	constant current plug driver*	included (memory last step)



# Light Stick

[ Finishes ] // **Nickel coating** (metal plating process) is chosen by the designer for its elegant and warm finish. To prevent any natural oxidation process, it requires regular cleaning. In alternative to nickel coating, customized finishes (i.e. chrome plating) can be provided upon request.

[ Note ] // The **lumen** value refers to the rated lumen output of the light source; for the lamp's output please refer to our bim files (see website). / ( \* ) Our LEDs can be dimmed by using compatible dimmers tested specifically to dim very low loads. We suggest checking the minimum load of the dimmer before installation. / ( \*\* ) The plug driver 110-240V is supplied with the electrical plug suitable for the market of reference only. Please specify in stage of order if the destination of the product differs from your standard.

p. 123

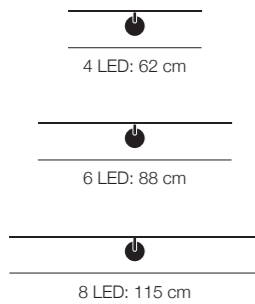

## Light Stick CW / wall or ceiling lamp

		voltage	source	type	watt	lumen	K	CRI	en. class	driver/transformer	dimming
LSP4 / nickel rod and base	€ 695,00	240V (110V available with not dimmable driver)	constant current LED 350 mA	interch. LED	4x1W 4W	596	2700	85	D	constant current driver	YES IGBT/Triac*
LSP4G / satin gold rod and base	€ 795,00				6x1W 6W	894					
LSP6 / nickel rod and base	€ 860,00	240V (110V available on request)	constant current LED 350 mA	interch. LED	8x1W 8W	1192	2700	85	D	constant current driver	YES IGBT/Triac*
LSP6G / satin gold rod and base	€ 980,00										
LSP8 / nickel rod and base	€ 1.025,00										
LSP8G / satin gold rod and base	€ 1.165,00										

base Ø 9x3,5 cm  
H ledge 17 cm

p. 125

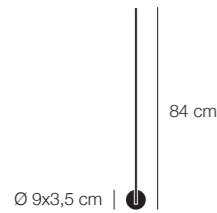

## Light Stick V / wall lamp

		voltage	source	type	watt	lumen	K	CRI	en. class	driver/transformer	dimming
LSPV6 / nickel vertical rod and base	€ 860,00	240V (110V available with not dimmable driver)	constant current LED 350 mA	interch. LED	6x1W 6W	894	2700	85	D	constant current driver	YES IGBT/Triac*
LSPV6G / satin gold vertical rod and base	€ 980,00										

H ledge 17 cm

p. 126

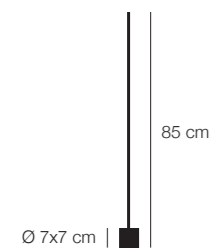

## Light Stick T / table lamp

		voltage	source	type	watt	lumen	K	CRI	en. class	driver/transformer	dimmer
LS6 / nickel rod / black base / black cable / black dimmer	€ 865,00	110-240V	constant current LED 350 mA	interch. LED	6x1W 6W	894	2700	85	D	constant current plug driver**	included (memory last step)
LS6G / satin gold rod / black base / black cable / black dimmer	€ 985,00										

p. 127

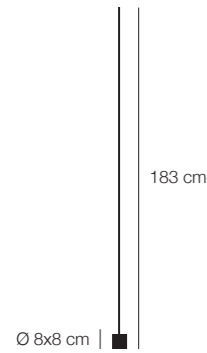

**Light Stick F** / standing lamp

		voltage	source	type	watt	lumen	K	CRI	en. class	driver/transformer	dimmer
LSF10B / black rod / black base / black wires / black dimmer	€ 1.120,00	110-240V	constant current LED 350 mA	interch. LED	10x1W 10W	1490	2700	85	D	constant current plug driver**	included (memory last step)
LSF10 / nickel rod / black base / black wires / black dimmer	€ 1.365,00										
LSF10G / satin gold rod / black base / black wires / black dimmer	€ 1.545,00										

**Wa Wa**

[ *Finishes* ] // **Nickel coating** (metal plating process) is chosen by the designer for its elegant and warm finish. To prevent any natural oxidation process, it requires regular cleaning. In alternative to nickel coating, customized finishes (i.e. chrome plating) can be provided upon request. / **Untreated brass** (an alloy of copper and zinc) is a very elegant finish, yellow-gold in colour, with an excellent corrosion resistance. We use it untreated, therefore it may oxidise with time. Regular cleaning helps preserving its original appearance and slow down the ageing process, which might be anyway accelerated by the weather, frequent handling or conditions of high humidity. / **Copper** is a very malleable and ductile metal, chosen for its high thermal and electrical conductivity, as well as for its typical reddish-orange colour. We use it untreated, therefore it may oxidise with time, forming a green patina. Regular cleaning helps preserving its original appearance and slow down the ageing process, which might be anyway accelerated by the weather, frequent handling or conditions of high humidity.

[ *Note* ] // The **lumen** value refers to the rated lumen output of the light source; for the lamp's output please refer to our bim files (see website). / ( \* ) Our LEDs can be dimmed by using compatible dimmers tested specifically to dim very low loads. We suggest checking the minimum load of the dimmer before installation. / ( \*\* ) The plug driver 110-240V is supplied with the electrical plug suitable for the market of reference only. Please specify in stage of order if the destination of the product differs from your standard.

p. 130

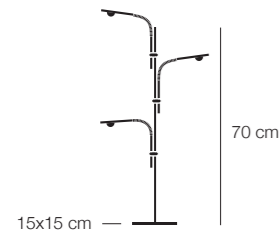

**Wa Wa T** / table lamp

		voltage	source	type	watt	lumen	K	CRI	en. class	driver/transformer	dimmer
WW / nickel structure, base and sticks / glass lens / blue wires / black dimmer	€ 935,00	110-240V	constant current LED 350 mA	interch. LED	3x1W 3W	447	2700	85	D	constant current plug driver**	included (memory last step)

p. 133

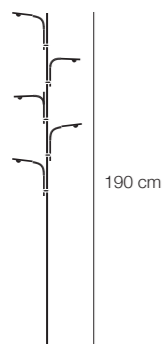

**Wa Wa F** / standing lamp

		voltage	source	type	watt	lumen	K	CRI	en. class	driver/transformer	dimmer
WWF / nickel structure, base and sticks / glass lens / black wires / black dimmer	€ 1.885,00	110-240V	constant current LED 350 mA	interch. LED	5x1W 5W	745	2700	85	D	constant current plug driver**	included (memory last step)
WWFBR / brass base and structure / copper sticks / glass lens / black wires / black dimmer	€ 1.985,00										

base cod. WWF: 20x20 cm  
base cod. WWFBR: 16x16 cm

p. 134

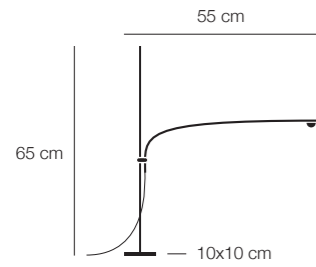

Uau T / table lamp

		voltage	source	type	watt	lumen	K	CRI	en. class	driver/transformer	dimmer
UAU / nickel structure and base / glass lens / blue wire / black dimmer	€ 640,00	110-240V	constant current LED 350 mA	interch. LED	1x1W	149	2700	85	D	constant current plug driver**	included (memory last step)

p. 135

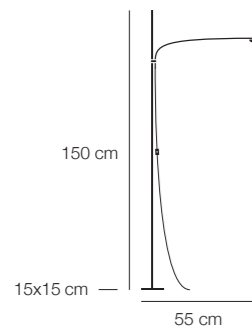

Uau F / standing lamp

		voltage	source	type	watt	lumen	K	CRI	en. class	driver/transformer	dimmer
UAUF / nickel structure and base / glass lens / blue wire / black dimmer	€ 760,00	110-240V	constant current LED 350 mA	interch. LED	1x1W	149	2700	85	D	constant current plug driver**	included (memory last step)

## Giulietta

[ Finishes ] // **Untreated brass** (an alloy of copper and zinc) is a very elegant finish, yellow-gold in colour, with an excellent corrosion resistance. We use it untreated, therefore it may oxidise with time. Regular cleaning helps preserving its original appearance and slow down the ageing process, which might be anyway accelerated by the weather, frequent handling or conditions of high humidity.

[ Note ] // The **lumen** value refers to the rated lumen output of the light source; for the lamp's output please refer to our bim files (see website).

p. 139

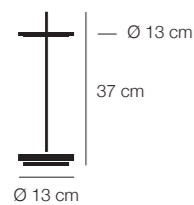

Giulietta BE T / battery table lamp

		battery	source	type	watt	lumen	K	CRI	en. class	battery charger	dimmer
GBB / black hoop and base / brass rod	€ 635,00	Li-ION 3,7V 4100 mAh	constant voltage LED	LED board	1x2,6W	189	2700	>90	G	input 110/240V output 5V@1,2 A (EU or UK plug only)	included touch
GBBR / vintage brass hoop and base / brass rod	€ 735,00										

p. 141

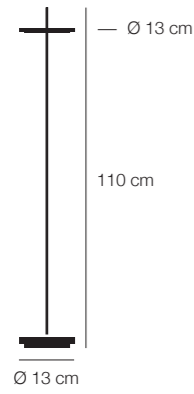

**Giuletta BE F / battery standing lamp**

		battery	source	type	watt	lumen	K	CRI	en. class	battery charger	dimmer
GBFB / black hoop and base / brass rod	€ 785,00	Li-ION 3,7V 4100 mAh	constant voltage LED	LED board	1x2,6W	189	2700	>90	G	input 110/240V output 5V@1,2 A (EU or UK plug only)	included touch
GBFBR / vintage brass hoop and base / brass rod	€ 885,00										

p. 142

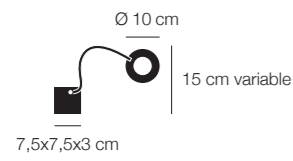

**Giuletta W / wall lamp**

		voltage	source	type	watt	lumen	K	CRI	en. class	driver/transformer	dimming
GPB / black structure / black hoop	€ 470,00	110V or 240V	constant voltage LED 5V	LED board	1x2,6W	189	2700	>90	G	constant voltage driver	included touch-less (memory last step)
GPNC / black structure / nickel hoop	€ 485,00										

p. 143

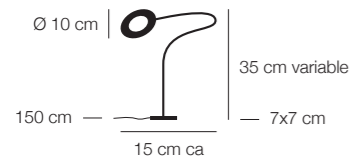

**Giuletta T / USB table lamp**

		voltage	source	type	watt	lumen	K	CRI	en. class	driver/transformer	dimmer
GB / black structure / black hoop / black wire	€ 480,00	110-240V	constant voltage LED 5V	LED board	1x2,6W	189	2700	>90	G	USB plug driver (EU or UK plug only)	included touch-less (memory last step)
GNC / black structure / nickel hoop / black wire	€ 495,00										

p. 145

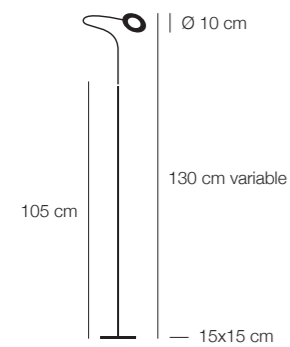

**Giuletta F / USB standing lamp**

		voltage	source	type	watt	lumen	K	CRI	en. class	driver/transformer	dimmer
GFB / nickel base and rod / black flex / black hoop / black wire	€ 915,00	110-240V	constant voltage LED 5V	LED board	1x2,6W	189	2700	>90	G	USB plug driver (EU or UK plug only)	included touch-less (memory last step)
GFNC / nickel base and rod / black flex / nickel hoop / black wire	€ 930,00										

# Jackie O

[ Finishes ] // **Nickel coating** (metal plating process) is chosen by the designer for its elegant and warm finish. To prevent any natural oxidation process, it requires regular cleaning. In alternative to nickel coating, customized finishes (i.e. chrome plating) can be provided upon request. / **Satin Steel** - the standard modular metal bases are composed of a satin steel plate mounted on a white lacquered metal frame and fixed to it by nickel square-head screws. On request we can supply the plate white matt lacquered as the frame or in different RAL colours.

[ Note ] // The **lumen** value refers to the rated lumen output of the light source; for the lamp's output please refer to our bim files (see website). / ( \* ) Our LEDs can be dimmed by using compatible dimmers tested specifically to dim very low loads. We suggest checking the minimum load of the dimmer before installation.

p. 149

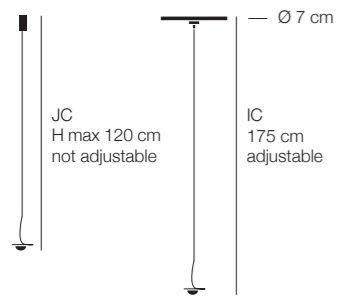

## Jackie O JC / IC / recessed pendant lamp for plasterboard ceiling

	voltage	source	type	watt	lumen	K	CRI	en. class	driver/transformer	dimming
JOJCLVO / mod. JC / nickel jack connection / blue wire / nickel curl	-	constant voltage 24V LED	LED Jack/interch.	1x1,1W	63	2700	90	G	not included available on request	-
JOICLVO / mod. IC / nickel plate with tensioner / blue wire / nickel curl			interch. LED							

installation hole Jackie O JC Ø 1,25 cm  
installation hole Jackie O IC Ø 5,5 cm  
max plasterboard thickness 12,5 mm

p. 150

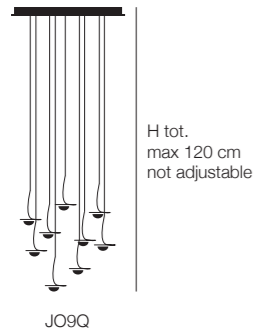

## Jackie O Chandelier 6 / 9 / 12 / pendant lamp

	voltage	source	type	watt	lumen	K	CRI	en. class	driver/transformer	dimming
JO6QLVO / satin steel base 30x30 cm / blue wires / nickel curls	240V (available 110V DALI dimmable)	constant voltage 24V LED	LED Jack/interch.	6x1,1W 6,6W	378	2700	90	G	constant voltage driver	YES IGBT/Triac*
JO9QLVO / satin steel base 30x30 cm / blue wires / nickel curls				9x1,1W 9,9W	567					
JO12QLVO / satin steel base 30x30 cm / blue wires / nickel curls				12x1,1W 13,2W	756					

p. 150

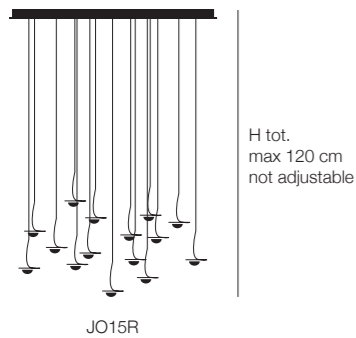

## Jackie O Chandelier 15 / 20 / 24 / pendant lamp

	voltage	source	type	watt	lumen	K	CRI	en. class	driver/transformer	dimming
JO15QLVO / satin steel base 60x60 cm / blue wires / nickel curls	110V or 240V	constant voltage 24V LED	LED Jack/interch.	15x1,1W 16,5W	945	2700	90	G	constant voltage driver	YES IGBT/Triac*
JO15RLVO / satin steel base 150x30 cm / blue wires / nickel curls				20x1,1W 22W	1260					
JO20QLVO / satin steel base 60x60 cm / blue wires / nickel curls				24x1,1W 26,4W	1512					
JO20RLVO / satin steel base 150x30 cm / blue wires / nickel curls										
JO24QLVO / satin steel base 60x60 cm / blue wires / nickel curls										
JO24RLVO / satin steel base 150x30 cm / blue wires / nickel curls										

# PostKrisi

[ Finishes ] // **Hand painting** is chosen for its deliberate textured effect and uniqueness of result. Any irregularities or unevenness in the coating cannot be considered defect, but rather a hallmark of the artisanal crafting process. / **Untreated brass** (an alloy of copper and zinc) is a very elegant finish, yellow-gold in colour, with an excellent corrosion resistance. We use it untreated, therefore it may oxidise with time. Regular cleaning helps preserving its original appearance and slow down the ageing process, which might be anyway accelerated by the weather, frequent handling or conditions of high humidity. / **Copper** is a very malleable and ductile metal, chosen for its high thermal and electrical conductivity, as well as for its typical reddish-orange colour. We use it untreated, therefore it may oxidise with time, forming a green patina. Regular cleaning helps preserving its original appearance and slow down the ageing process, which might be anyway accelerated by the weather, frequent handling or conditions of high humidity. / **Nickel coating** (metal plating process) is chosen by the designer for its elegant and warm finish. To prevent any natural oxidation process, it requires regular cleaning. In alternative to nickel coating, customized finishes (i.e. chrome plating) can be provided upon request. / **Satin Steel** - the standard modular metal bases are composed of a satin steel plate mounted on a white lacquered metal frame and fixed to it by nickel square-head screws. On request we can supply the plate white matt lacquered as the frame or in different RAL colours.

[ Note ] // The **lumen** value refers to the rated lumen output of the light source; for the lamp's output please refer to our bim files (see website). / ( \* ) LED bulbs can be dimmed using compatible dimmers, which have been tested specifically for dimming very low loads. The manufacturers of LED bulbs are required to draw up a list of suggested dimmers for the dimming of their products, with an indication of the maximum number of bulbs dimmable with the various types of dimmer. / ( \*\* ) The plug driver 110-240V is supplied with the electrical plug suitable for the market of reference only. Please specify in stage of order if the destination of the product differs from your standard.

p. 156

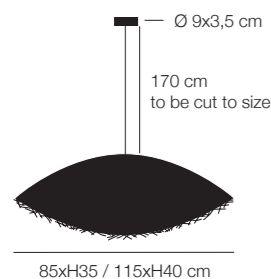

## PostKrisi 50 / 51 / pendant lamp

		voltage	source	type	watt	lumen	K	CRI	en. class	driver/transformer	dimming
PK50LN / PostKrisi 50 / shade 85x35 cm natural / grey braided cable / nickel base	€ 720,00	110V (bulb not supplied)-240V	mains voltage LED	E27 bulb	1x8W	900	2700	>80	E	-	YES IGBT/Triac*
PK51LN / PostKrisi 51 / shade 115x40 cm natural / grey braided cable / nickel base	€ 970,00										
PK50LW / PostKrisi 50 / shade 85x35 cm white / grey braided cable / nickel base	€ 790,00	110V (bulb not supplied)-240V	mains voltage LED	E27 bulb silver crowned	1x7W	600	2700	>80	F	-	YES IGBT/Triac*
PK51LW / PostKrisi 51 / shade 115x40 cm white / grey braided cable / nickel base	€ 1.040,00										
PK50LG / PostKrisi 50 / shade 85x35 cm gold / grey braided cable / nickel base	€ 965,00										
PK51LG / PostKrisi 51 / shade 115x40 cm gold / grey braided cable / nickel base	€ 1.215,00										
PK50LS / PostKrisi 50 / shade 85x35 cm silver / grey braided cable / nickel base	€ 965,00										
PK51LS / PostKrisi 51 / shade 115x40 cm silver / grey braided cable / nickel base	€ 1.215,00										

weight: PK50 1,5 kg / PK51 2,8 kg

p. 156

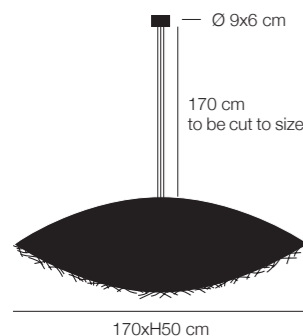

## PostKrisi 52 / pendant lamp

		voltage	source	type	watt	lumen	K	CRI	en. class	driver/transformer	dimming
PK52LN / natural shade / grey braided cables / nickel base	€ 1.270,00	110V (bulbs not supplied)-240V	mains voltage LED	E27 bulb	3x8W 24W	2700	2700	>80	E	-	YES IGBT/Triac*
PK52LW / white shade / grey braided cables / nickel base	€ 1.430,00										
PK52LG / gold shade / grey braided cables / nickel base	€ 1.770,00	110V (bulbs not supplied)-240V	mains voltage LED	E27 bulb silver crowned	3x7W 21W	1800	2700	>80	F	-	YES IGBT/Triac*
PK52LS / silver shade / grey braided cables / nickel base	€ 1.770,00										

weight 3 kg

p. 161

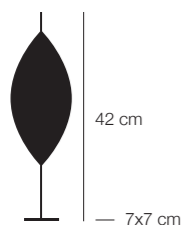

## PostKrisi 10 Malagolina / table lamp

		voltage	source	type	watt	lumen	K	CRI	en. class	driver/transformer	dimmer
PKM10LN / natural shade / nickel base and structure / blue wire / black dimmer	€ 600,00	110-240V	constant current LED 350 mA	interch. LED	2x1W 2W	298	2700	85	D	constant current plug driver**	included (memory last step)
PKM10LW / white shade / nickel base and structure / blue wire / black dimmer	€ 620,00										
PKM10LG / gold shade / nickel base and structure / blue wire / black dimmer	€ 650,00										
PKM10LS / silver shade / nickel base and structure / blue wire / black dimmer	€ 650,00										

p. 162

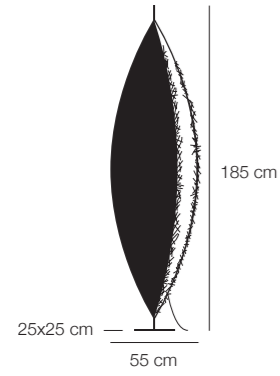

**PostKrisi F 100 / standing lamp**

	price	voltage	source	type	watt	lumen	K	CRI	en. class	driver/transformer	dimmer
PKF100W / white shade / nickel base and structure / black wires / black dimmer	€ 2.425,00	110-240V	constant current LED 350 mA	interch. LED	8x1W 8W	1192	2700	85	D	constant current plug driver**	included (memory last step)
PKF100G / gold shade / nickel base and structure / black wires / black dimmer	€ 2.495,00										
PKF100S / silver shade / nickel base and structure / black wires / black dimmer	€ 2.495,00										

p. 164

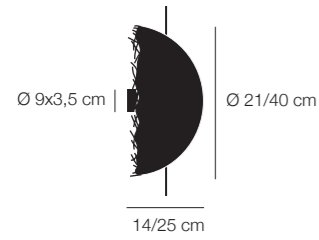

**PostKrisi W 21 / 40 / wall lamp**

	price	voltage	source	type	watt	lumen	K	CRI	en. class	driver/transformer	dimming
PKP21LN / PostKrisi W 21 / shade Ø 21 cm natural / nickel base	€ 525,00	110-240V	constant current LED 350 mA	interch. LED	2x1W 2W	298	2700	85	D	constant current driver	NO av. on request
PKP21LW / PostKrisi W 21 / shade Ø 21 cm white / nickel base	€ 545,00										
PKP21LG / PostKrisi W 21 / shade Ø 21 cm gold / nickel base	€ 570,00										
PKP21LS / PostKrisi W 21 / shade Ø 21 cm silver / nickel base	€ 570,00										
PKP40LW / PostKrisi W 40 / shade Ø 40 cm white / nickel base	€ 730,00										
PKP40LG / PostKrisi W 40 / shade Ø 40 cm gold / nickel base	€ 760,00										
PKP40LS / PostKrisi W 40 / shade Ø 40 cm silver / nickel base	€ 760,00										

Ø 21 cm: rod H 22 cm  
Ø 40 cm: rod H 60 cm

p. 167

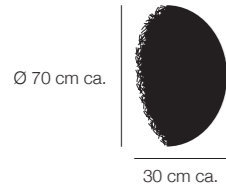

**PostKrisi CW 70 / ceiling or wall lamp**

	price	voltage	source	type	watt	lumen	K	CRI	en. class	driver/transformer	dimming
PKCW7LVOG / gold shade	€ 1.415,00	240V (available 110V DALI dimmable)	constant current LED 450 mA	COB LED	1x15W	2187	2700	>80	D	constant current LED driver	YES Triac
PKCW7LVOS / silver shade	€ 1.415,00										

p. 168

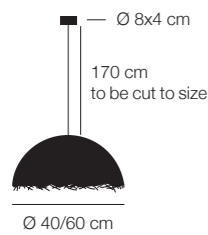

**PostKrisi 49 / pendant lamp**

	price	voltage	source	type	watt	lumen	K	CRI	en. class	driver/transformer	dimming
PK494LWG / shade Ø 40 cm white/gold / white braided cable / white base	€ 695,00	110V (bulb not supplied)-240V	mains voltage LED	E27 bulb silver crowned	1x7W	600	2700	>80	F	-	YES IGBT/Triac*
PK494LWS / shade Ø 40 cm white/silver / white braided cable / white base	€ 695,00										
PK496LWG / shade Ø 60 cm white/gold / white braided cable / white base	€ 855,00										
PK496LWS / shade Ø 60 cm white/silver / white braided cable / white base	€ 855,00										

weight: Ø 40 cm 1 kg / Ø 60 cm 1,5 kg

p. 168

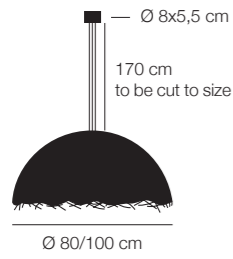

**PostKrisi 49 / pendant lamp**

PK498LWG / shade Ø 80 cm white/gold / white braided cable / white base	€	1.170,00
PK498LWS / shade Ø 80 cm white/silver / white braided cable / white base	€	1.170,00
PK4910LWG / shade Ø 100 cm white/gold / white braided cable / white base	€	1.570,00
PK4910LWS / shade Ø 100 cm white/silver / white braided cable / white base	€	1.570,00

voltage	source	type	watt	lumen	K	CRI	en. class	driver/transformer	dimming
110V (bulbs not supplied)-240V	mains voltage LED	E27 bulb silver crowned	3x7W 21W	1800	2700	>80	F	-	YES IGBT/Triac*

weight: Ø 80 cm 2,8 kg / Ø 100 cm 3 kg

p. 171

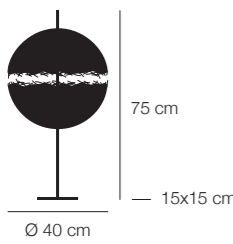

**PostKrisi T 61 / table lamp**

PK61LN / natural shades / black base / brass rod / black cable and dimmer	€	1.030,00
PK61LNNC / natural shades / nickel rod and base / black cable and dimmer	€	1.030,00
PK61LW / white shades / black base / brass rod / black cable and dimmer	€	1.050,00
PK61LWNC / white shades / nickel rod and base / black cable and dimmer	€	1.050,00

voltage	source	type	watt	lumen	K	CRI	en. class	driver/transformer	dimmer
110V (bulbs not supplied)-240V	mains voltage LED	E27 bulb	3x8W 24W	2700	2700	>80	E	-	included (memory last step)

p. 172

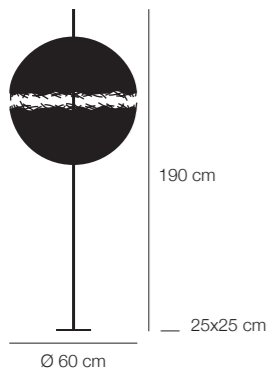

**PostKrisi F 64 / standing lamp**

PK64LN / natural shades / black base / brass rod / black cable and dimmer	€	1.240,00
PK64LNNC / natural shades / nickel rod and base / black cable and dimmer	€	1.240,00
PK64LW / white shades / black base / brass rod / black cable and dimmer	€	1.260,00
PK64LWNC / white shades / nickel rod and base / black cable and dimmer	€	1.260,00

voltage	source	type	watt	lumen	K	CRI	en. class	driver/transformer	dimmer
110V (bulbs not supplied)-240V	mains voltage LED	E27 bulb	3x8W 24W	2700	2700	>80	E	-	included (memory last step)

p. 174

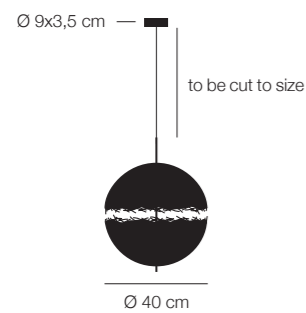

**PostKrisi 65 / pendant lamp**

PK65LN / shades Ø 40 cm natural / brass structure / black cable and base	€	870,00
PK65LNNC / shades Ø 40 cm natural / nickel structure and base / black cable	€	870,00
PK65LW / shades Ø 40 cm white / brass structure / black cable and base	€	890,00
PK65LWNC / shades Ø 40 cm white / nickel structure and base / black cable	€	890,00

voltage	source	type	watt	lumen	K	CRI	en. class	driver/transformer	dimming
110V (bulbs not supplied)-240V	mains voltage LED	E27 bulb	3x8W 24W	2700	2700	>80	E	-	YES IGBT/Triac*

H 200 cm / H rod 63 cm / weight 2,5 kg



p. 174

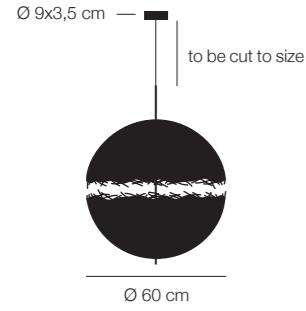

**PostKrisi 66 / pendant lamp**

PK66LN / shades Ø 60 cm natural / brass structure / black cable and base	€	1.170,00
PK66LNNC / shades Ø 60 cm natural / nickel structure and base / black cable	€	1.170,00
PK66LW / shades Ø 60 cm white / brass structure / black cable and base	€	1.190,00
PK66LWNC / shades Ø 60 cm white / nickel structure and base / black cable	€	1.190,00

voltage	source	type	watt	lumen	K	CRI	en. class	driver/transformer	dimming
110V (bulbs not supplied)-240V	mains voltage LED	E27 bulb	3x8W 24W	2700	2700	>80	E	-	YES IGBT/Triac*

H 210 cm / H rod 83 cm / weight 3,5 kg

p. 174

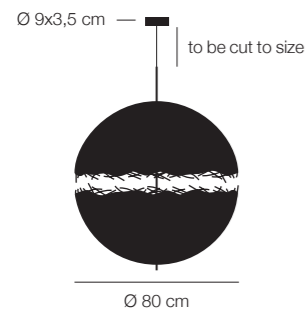

**PostKrisi 67 / pendant lamp**

PK67LN / shades Ø 80 cm natural / brass structure / black cable and base	€	2.090,00
PK67LNNC / shades Ø 80 cm natural / nickel structure and base / black cable	€	2.090,00
PK67LW / shades Ø 80 cm white / brass structure / black cable and base	€	2.110,00
PK67LWNC / shades Ø 80 cm white / nickel structure and base / black cable	€	2.110,00

voltage	source	type	watt	lumen	K	CRI	en. class	driver/transformer	dimming
110V (bulbs not supplied)-240V	mains voltage LED	E27 bulb	3x8W 24W	2700	2700	>80	E	-	YES IGBT/Triac*

H 220 cm / H rod 100 cm / weight 5 kg

p. 176

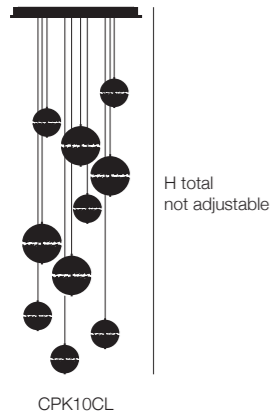

**PostKrisi Chandelier / pendant lamp**

CPK3QL / satin base 30x30 cm / 3x PK14 / H 180 cm	€	1.140,00
CPK5QL / satin base 30x30 cm / 5x PK14 / H 180 cm	€	1.900,00
CPK7CL / satin base Ø 40 cm / 7x PK14 / H 180 cm	€	2.660,00
CPK7QL / satin base 60x60 cm / 7x PK14 / H 180 cm	€	2.660,00
CPK7RL / satin base 90x30 cm / 3x PK20 and 4x PK14 / H 180 cm	€	2.810,00
CPK10CL / satin base Ø 78 cm / 4x PK20 and 6x PK14 / H 300 cm	€	4.000,00

voltage	source	type	watt	lumen	K	CRI	en. class	driver/transformer	dimming
110V or 240V	12V DC LED bulb	G4 bulb	3x0,8W 2,4W	207	2700	80	G	low voltage driver	NO
240V (110V available with not dimmable driver)	12V DC LED bulb	G4 bulb	5x0,8W 4W	345	2700	80	G	low voltage driver	YES Triac
			7x0,8W 5,6W	483					
			10x0,8W 8W	690					

PK14 = PostKrisi sphere Ø 14 cm natural with jack

PK20 = PostKrisi sphere Ø 20 cm natural with jack

## Fil de Fer

[ Finishes ] // **Nickel coating** (metal plating process) is chosen by the designer for its elegant and warm finish. To prevent any natural oxidation process, it requires regular cleaning. In alternative to nickel coating, customized finishes (i.e. chrome plating) can be provided upon request. / **Rough iron** (untreated metal) is chosen by the designer specifically because of its uniqueness and its natural ageing property. The appearance of any uneven rust patches does not constitute a defect, since it is a typical sign of the ageing process, which might be considerably accelerated in conditions of high humidity or direct exposure to outdoor weathering. / **Satin Steel** - the standard modular metal bases are composed of a satin steel plate mounted on a white lacquered metal frame and fixed to it by nickel square-head screws. On request we can supply the plate white matt lacquered as the frame or in different RAL colours

[ Note ] // The **lumen** value refers to the rated lumen output of the light source; for the lamp's output please refer to our bim files (see website).

[ Cables ] // ( **s** ) suspension cable. / ( **el** ) electrical cable.

p. 180

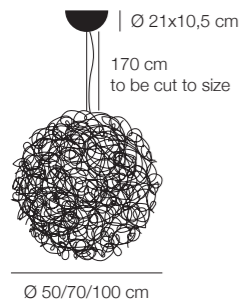

### Fil de Fer / pendant lamp

		voltage	source	type	watt	lumen	K	CRI	en. class	driver/transformer	dimming
F5SL / Ø 50 cm aluminium / steel cable <sup>(s)</sup> / grey braided cable <sup>(el)</sup> / nickel base	€ 1.550,00	240V (110V available with not dimmable driver)	12V DC LED bulb	G4 bulb	12x0,8W 9,6W	828	2700	80	G	electronic 12V DC low voltage	YES Triac
F5SLG / Ø 50 cm matt gold anodized / steel cable <sup>(s)</sup> / gold braided cable <sup>(el)</sup> / gold-plated base	€ 1.790,00				18x0,8W 14,4W	1242					
F7SL / Ø 70 cm aluminium / steel cable <sup>(s)</sup> / grey braided cable <sup>(el)</sup> / nickel base	€ 1.950,00				24x0,8W 19,2W	1656					
F7SLG / Ø 70 cm matt gold anodized / steel cable <sup>(s)</sup> / gold braided cable <sup>(el)</sup> / gold-plated base	€ 2.310,00										
F10SL / Ø 100 cm aluminium / steel cable <sup>(s)</sup> / grey braided cable <sup>(el)</sup> / nickel base	€ 2.545,00										
F10SLG / Ø 100 cm matt gold anodized / steel cable <sup>(s)</sup> / gold braided cable <sup>(el)</sup> / gold-plated base	€ 3.075,00										

weight: Ø 50 8 kg / Ø 70 10 kg / Ø 100 16 kg

p. 185

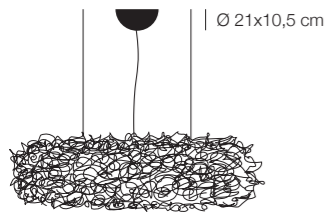

### Fil de Fer Nuvola / pendant lamp

		voltage	source	type	watt	lumen	K	CRI	en. class	driver/transformer	dimming
FNVAL / mod. A / aluminium / steel cables <sup>(s)</sup> / grey braided cable <sup>(el)</sup> / nickel base	€ 2.905,00	110V* or 240V	12V DC LED bulb	G4 bulb	24x0,8W 19,2W	1656	2700	80	G	electronic 12V DC low voltage	YES Triac
FNVEL / mod. E / aluminium / steel cables <sup>(s)</sup> / grey braided cable <sup>(el)</sup> / nickel base	€ 4.215,00				36x0,8W 28,8W	2484					
FNVFL / mod. F / aluminium / steel cables <sup>(s)</sup> / grey braided cable <sup>(el)</sup> / nickel base	€ 5.235,00				44x0,8W 35,2W	3036					

\* mod. A 110V available with not dimmable driver

Further dimensions and gold finish available on request.

mod. A / 120x50x H 35 cm / weight 10 kg  
mod. E / 200x80x H 50 cm / weight 14 kg  
mod. F / 240x140x H 50 cm / weight 21 kg  
cables 170 cm to be cut to size

p. 189

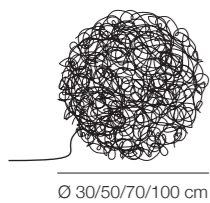

### Fil de Fer F / floor lamp

		voltage	source	type	watt	lumen	K	CRI	en. class	driver/transformer	dimmer
F3L / Ø 30 cm aluminium / grey braided cable / black dimmer	€ 1.135,00	110-240V	12V DC LED bulb	G4 bulb	8x0,8W 6,4W	552	2700	80	G	low voltage plug driver	included (memory last step)
F3LG / Ø 30 cm gold / gold braided cable / black dimmer	€ 1.245,00				10x0,8W 8W	690					
F5L / Ø 50 cm aluminium / grey braided cable / black dimmer	€ 1.550,00				15x0,8W 12W	1035					
F5LG / Ø 50 cm gold / gold braided cable / black dimmer	€ 1.790,00				20x0,8W 16W	1380					
F7L / Ø 70 cm aluminium / grey braided cable / black dimmer	€ 1.950,00										
F7LG / Ø 70 cm gold / gold braided cable / black dimmer	€ 2.310,00										
F10L / Ø 100 cm aluminium / grey braided cable / black dimmer	€ 2.545,00										
F10LG / Ø 100 cm gold / gold braided cable / black dimmer	€ 3.075,00										

12V cable: 170 cm / plug cable: 180 cm

p. 191

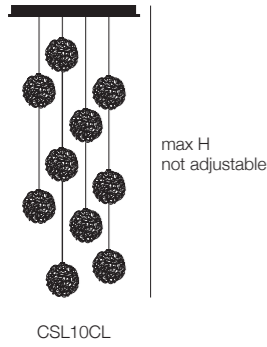

**Sweet Light Chandelier / pendant lamp**

		voltage	source	type	watt	lumen	K	CRI	en. class	driver/transformer	dimming
CSL3QL / 3x Sweet Light Ø 10 cm / satin base 30x30 cm / H 180 cm	€ 900,00	110V or 240V	12V DC LED bulb	G4 bulb	3x0,8W 2,4W	207	2700	80	G	low voltage driver	NO
CSL5QL / 5x Sweet Light Ø 10 cm / satin base 30x30 cm / H 180 cm	€ 1.500,00	240V (110V available with not dimmable driver)	12V DC LED bulb	G4 bulb	5x0,8W 4W	345	2700	80	G	low voltage driver	YES Triac
CSL7CL / 7x Sweet Light Ø 10 cm / satin base Ø 40 cm / H 180 cm	€ 2.100,00				7x0,8W 5,6W	483					
CSL7QL / 7x Sweet Light Ø 10 cm / satin base 60x60 cm / H 180 cm	€ 2.100,00				10x0,8W 8W	690					
CSL10CL / 10x Sweet Light Ø 10 cm / satin base Ø 78 cm / H 180 cm	€ 3.000,00				15x0,8W 12W	1035					
CSL15QL / 15x Sweet Light Ø 10 cm / satin base 60x60 cm / H 300 cm	€ 4.500,00				20x0,8W 16W	1380					
CSL20CL / 20x Sweet Light Ø 10 cm / satin base Ø 78 cm / H 300 cm	€ 6.000,00				35x0,8W 28W	2415					
CSL35CL / 35x Sweet Light Ø 10 cm / satin base Ø 78 cm / H 400 cm	€ 10.500,00										

Standard version with aluminium Sweet Light spheres.

For further models see also PostKrisi Chandelier page 44.

p. 192

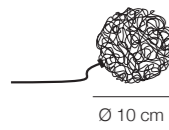

**Sweet Light T / table lamp**

		voltage	source	type	watt	lumen	K	CRI	en. class	driver/transformer	dimmer
SLL / Ø 10 cm aluminium / blue wire	€ 295,00	110-240V	12V DC LED bulb	G4 bulb	1x0,8W	69	2700	80	G	low voltage plug driver	included touch (on the sphere)
SLLBR / Ø 10 cm brass / blue wire	€ 300,00										
SLLS / Ø 10 cm silver / blue wire	€ 340,00										

cable: 250 cm

p. 195

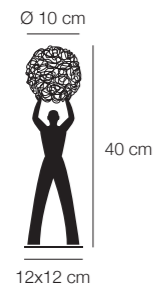

**Uomo della Luce S / table lamp**

		voltage	source	type	watt	lumen	K	CRI	en. class	driver/transformer	dimmer
USL / rough iron structure / sphere Ø 10 cm aluminium / black dimmer / black wires	€ 750,00	110-240V	12V DC LED bulb	G4 bulb	1x0,8W	69	2700	80	G	low voltage plug driver	included (memory last step)

# Lucenera

[ Finishes ] // **Nickel coating** (metal plating process) is chosen by the designer for its elegant and warm finish. To prevent any natural oxidation process, it requires regular cleaning. In alternative to nickel coating, customized finishes (i.e. chrome plating) can be provided upon request. / **Carbon tubes**. The production of the tubes is partially craftmade. Any imperfection in the texture is a peculiarity of the product and sign of craftsmanship. The quality of the tubes is guaranteed by using LED bulbs only, preferably with the max wattage included in our standard products.

[ Note ] // The **lumen** value refers to the rated lumen output of the light source; for the lamp's output please refer to our bim files (see website). / (\*) LED bulbs can be dimmed using compatible dimmers, which have been tested specifically for dimming very low loads. The manufacturers of LED bulbs are required to draw up a list of suggested dimmers for the dimming of their products, with an indication of the maximum number of bulbs dimmable with the various types of dimmer.

p. 199

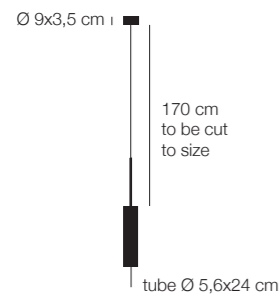

## Lucenera 504 / pendant lamp

		voltage	source	type	watt	lumen	K	CRI	en. class	driver/transformer	dimming
L504L / black tube and base / metal braided cable / nickel details	€ 540,00	110V (bulb not supplied)-240V	mains voltage LED	GU10 bulb	1x5,5W	375	3000	>90	G	-	YES IGBT/Triac*
L504LW / white tube and base / metal braided cable / nickel details	€ 540,00										

p. 200

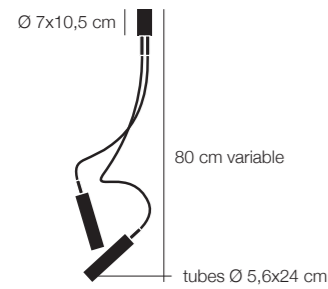

## Lucenera 206 / ceiling lamp

		voltage	source	type	watt	lumen	K	CRI	en. class	driver/transformer	dimming
L20680L / black tubes/base/flexible pipes / nickel details	€ 710,00	110V (bulbs not supplied)-240V	mains voltage LED	GU10 bulb	2x5,5W 11W	750	3000	>90	G	-	YES IGBT/Triac*
L20680LW / white tubes/base/flexible pipes / nickel details	€ 710,00										

p. 202-203



## Lucenera 502 / 503 / wall lamp

		voltage	source	type	watt	lumen	K	CRI	en. class	driver/transformer	dimming
L502L / Lucenera 502 / black tube/base/rod / nickel details	€ 515,00	110V (bulb not supplied)-240V	mains voltage LED	GU10 bulb	1x5,5W	375	3000	>90	G	-	NO on/off switch included
L502LW / Lucenera 502 / white tube/base/rod / nickel details	€ 515,00										
L503L / Lucenera 503 / black tubes/base/rods / nickel details	€ 745,00	110V (bulbs not supplied)-240V	mains voltage LED	GU10 bulb	2x5,5W 11W	750	3000	>90	G	-	NO on/off switch included
L503LW / Lucenera 503 / white tubes/base/rods / nickel details	€ 745,00										



p. 205

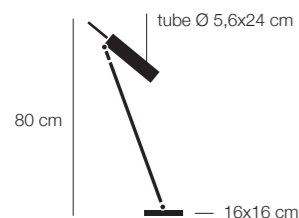

## Lucenera 500 / table lamp

L500L / black tube/base/stand / nickel details

€ 630,00

L500LW / white tube/base/stand / nickel details

€ 630,00

voltage	source	type	watt	lumen	K	CRI	en. class	driver/transformer	dimmer
240V (110V available with on/off - bulb not supplied)	mains voltage LED	GU10 bulb	1x5,5W	375	3000	>90	G	-	included (memory 0%)

p. 207

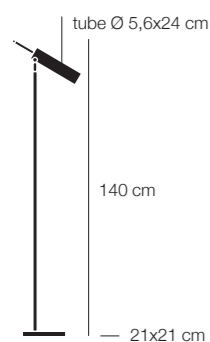

## Lucenera 506 / standing lamp

L506L / black tube/base/stand / nickel details

€ 685,00

L506LW / white tube/base/stand / nickel details

€ 685,00

voltage	source	type	watt	lumen	K	CRI	en. class	driver/transformer	dimmer
110V (bulb not supplied)-240V	mains voltage LED	GU10 bulb	1x5,5W	375	3000	>90	G	-	included (memory last step)

## Stchu-Moon

[ Finishes ] // **Rough iron** (untreated metal) is chosen by the designer specifically because of its uniqueness and its natural ageing property. The appearance of any uneven rust patches does not constitute a defect, since it is a typical sign of the ageing process, which might be considerably accelerated in conditions of high humidity or direct exposure to outdoor weathering. / **Nickel coating** (metal plating process) is chosen by the designer for its elegant and warm finish. To prevent any natural oxidation process, it requires regular cleaning. In alternative to nickel coating, customized finishes (i.e. chrome plating) can be provided upon request.

[ Cables ] // ( **s** ) suspension cable. / ( **el** ) electrical cable.

[ Note ] // The **lumen** value refers to the rated lumen output of the light source; for the lamp's output please refer to our bim files (see website). / ( **\*** ) LED bulbs can be dimmed using compatible dimmers, which have been tested specifically for dimming very low loads. The manufacturers of LED bulbs are required to draw up a list of suggested dimmers for the dimming of their products, with an indication of the maximum number of bulbs dimmable with the various types of dimmer. / ( **\*\*** ) The plug driver 110-240V is supplied with the electrical plug suitable for the market of reference only. Please specify in stage of order if the destination of the product differs from your standard.

p. 211

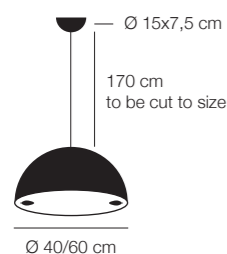

## Stchu-Moon 02 / pendant lamp

SM24LS / Ø 40 cm silver (exterior black) / steel spoons / black cable and base

€ 1.115,00

SM24LG / Ø 40 cm gold (exterior black) / steel spoons / black cable and base

€ 1.115,00

SM24LC / Ø 40 cm copper (exterior black) / steel spoons / black cable and base

€ 1.115,00

SM26LS / Ø 60 cm silver (exterior black) / steel spoons / black cable and base

€ 1.355,00

SM26LG / Ø 60 cm gold (exterior black) / steel spoons / black cable and base

€ 1.355,00

SM26LC / Ø 60 cm copper (exterior black) / steel spoons / black cable and base

€ 1.355,00

voltage	source	type	watt	lumen	K	CRI	en. class	driver/transformer	dimming
240V (110V available on request)	24V DC LED board	LED board	2x3,9W 7,8W	840	2700	80	F	electronic 24V DC low voltage	YES Triac

p. 211

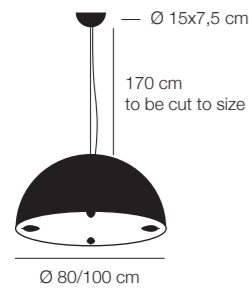

**Stchu-Moon 02 / pendant lamp**

SM28LS / Ø 80 cm silver (exterior black) / steel spoons / steel cable <sup>(6)</sup> / black cable <sup>(6)</sup> and base	€	1.725,00
SM28LG / Ø 80 cm gold (exterior black) / steel spoons / steel cable <sup>(6)</sup> / black cable <sup>(6)</sup> and base	€	1.725,00
SM28LC / Ø 80 cm copper (exterior black) / steel spoons / steel cable <sup>(6)</sup> / black cable <sup>(6)</sup> and base	€	1.725,00
SM210LS / Ø 100 cm silver (exterior black) / steel spoons / steel cable <sup>(6)</sup> / black cable <sup>(6)</sup> and base	€	2.545,00
SM210LG / Ø 100 cm gold (exterior black) / steel spoons / steel cable <sup>(6)</sup> / black cable <sup>(6)</sup> and base	€	2.545,00
SM210LC / Ø 100 cm copper (exterior black) / steel spoons / steel cable <sup>(6)</sup> / black cable <sup>(6)</sup> and base	€	2.545,00

voltage	source	type	watt	lumen	K	CRI	en. class	driver/transformer	dimming
240V (110V available on request)	24V DC LED board	LED board	4x3,9W 15,6W	1680	2700	80	F	electronic 24V DC low voltage	YES Triac

weight: Ø 80 cm 6,5 kg / Ø 100 cm 7,5 kg

p. 213

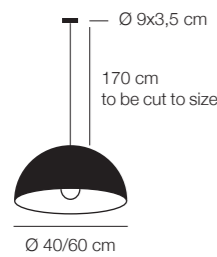

**Stchu-Moon 02 230V / pendant lamp**

SM24230LS / Ø 40 cm silver (exterior black) / black cable / nickel base	€	705,00
SM24230LG / Ø 40 cm gold (exterior black) / black cable / nickel base	€	705,00
SM24230LC / Ø 40 cm copper (exterior black) / black cable / nickel base	€	705,00
SM26230LS / Ø 60 cm silver (exterior black) / black cable / nickel base	€	945,00
SM26230LG / Ø 60 cm gold (exterior black) / black cable / nickel base	€	945,00
SM26230LC / Ø 60 cm copper (exterior black) / black cable / nickel base	€	945,00

voltage	source	type	watt	lumen	K	CRI	en. class	driver/transformer	dimming
110V (bulb not supplied)-240V	mains voltage LED	E27 bulb silver crowned	1x7W	600	2700	>80	F	-	YES IGBT/Triac*

weight: Ø 40 cm 1,8 kg / Ø 60 cm 2,8 kg

p. 213

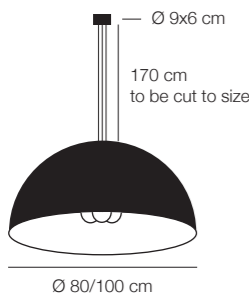

**Stchu-Moon 02 230V / pendant lamp**

SM28230LS / Ø 80 cm silver (exterior black) / black cables / nickel base	€	1.380,00
SM28230LG / Ø 80 cm gold (exterior black) / black cables / nickel base	€	1.380,00
SM28230LC / Ø 80 cm copper (exterior black) / black cables / nickel base	€	1.380,00
SM210230LS / Ø 100 cm silver (exterior black) / black cables / nickel base	€	1.740,00
SM210230LG / Ø 100 cm gold (exterior black) / black cables / nickel base	€	1.740,00
SM210230LC / Ø 100 cm copper (exterior black) / black cables / nickel base	€	1.740,00

voltage	source	type	watt	lumen	K	CRI	en. class	driver/transformer	dimming
110V (bulbs not supplied)-240V	mains voltage LED	E27 bulb silver crowned	3x7W 21W	1800	2700	>80	F	-	YES IGBT/Triac*

weight: Ø 80 cm 6,5 kg / Ø 100 cm 7,5 kg

p. 214

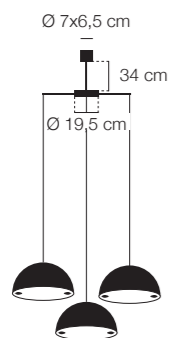

**Stchu-Moon 02 Chandelier / pendant lamp**

SM234LS / Ø 40 cm silver (exterior black) / steel spoons / black cables and structure	€	3.135,00
SM234LG / Ø 40 cm gold (exterior black) / steel spoons / black cables and structure	€	3.135,00
SM234LC / Ø 40 cm copper (exterior black) / steel spoons / black cables and structure	€	3.135,00
SM236LS / Ø 60 cm silver (exterior black) / steel spoons / black cables and structure	€	3.855,00
SM236LG / Ø 60 cm gold (exterior black) / steel spoons / black cables and structure	€	3.855,00
SM236LC / Ø 60 cm copper (exterior black) / steel spoons / black cables and structure	€	3.855,00

voltage	source	type	watt	lumen	K	CRI	en. class	driver/transformer	dimming
240V (110V available on request 1..10V or push dimm.)	24V DC LED board	LED board	6x3,9W 23,4W	2520	2700	80	F	electronic 24V DC low voltage	YES Triac

3x Ø 40 cm  
H max 190 cm / tot. Ø 105 cm / weight 13,5 kg  
3x Ø 60 cm  
H max 200 cm / tot. Ø 145 cm / weight 18,5 kg

p. 219

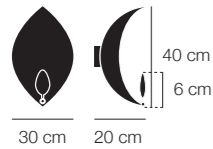

**Stchu-Moon 05 / wall lamp**

		voltage	source	type	watt	lumen	K	CRI	en. class	driver/transformer	dimming
SM5LS / silver (exterior white) / steel spoon / white base	€ 625,00	240V (110V available on request 1..10V or push dimm.)	24V DC LED board	LED board	1x3,9W	420	2700	80	F	electronic 24V DC low voltage	YES Triac
SM5LG / gold (exterior white) / steel spoon / white base	€ 625,00										
SM5LC / copper (exterior white) / steel spoon / white base	€ 625,00										

p. 220

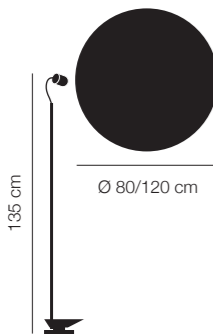

**Stchu-Moon 08 / wall/standing lamp**

		voltage	source	type	watt	lumen	K	CRI	en. class	driver/transformer	dimmer
SM88LS / Ø 80 cm silver (exterior grey matt) / nickel light structure / black anvil	€ 1.495,00	110-240V	low voltage LED 12V	GU5.3 bulb	1x7,5W	630	3000	90	F	-	included (memory last step)
SM88LG / Ø 80 cm gold (exterior grey matt) / nickel light structure / black anvil	€ 1.495,00										
SM88LC / Ø 80 cm copper (exterior grey matt) / nickel light structure / black anvil	€ 1.495,00										
SM812LS / Ø 120 cm silver (exterior grey matt) / nickel light structure / black anvil	€ 1.765,00										
SM812LG / Ø 120 cm gold (exterior grey matt) / nickel light structure / black anvil	€ 1.765,00										
SM812LC / Ø 120 cm copper (exterior grey matt) / nickel light structure / black anvil	€ 1.765,00										

H recommended distance  
from lamp to disc 25 cm ca

p. 221

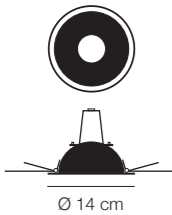

**Stchu-Moon R / recessed lamp for plasterboard ceiling**

		voltage	source	type	watt	lumen	K	CRI	en. class	driver/transformer	dimming
SMI14S / Ø 14 cm silver (bulb not included)	€ 235,00	-	mains voltage	GU10 bulb not included	-	-	-	-	-	-	-
SMI14G / Ø 14 cm gold (bulb not included)	€ 235,00										
SMI14C / Ø 14 cm copper (bulb not included)	€ 235,00										
LS4 / LED bulb	net price € 15,00	220-240V	mains voltage LED	GU10 bulb	5,5W	375	3000	>90	G	-	YES IGBT/Triac*

installation hole Ø 13 cm / depth 15 cm  
plasterboard thickness max 12,5 mm

p. 222

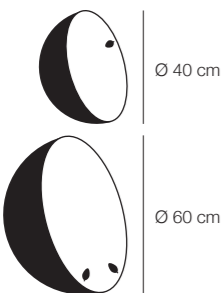

**Stchu-Moon 01 / floor lamp**

		voltage	source	type	watt	lumen	K	CRI	en. class	driver/transformer	dimmer
SM14LS / Ø 40 cm silver (ext. black) / steel spoon / metal braided cable / black dimmer/cable	€ 1.085,00	110-240V	24V DC LED board	LED board	1x3,9W	420	2700	80	F	low voltage plug driver**	included (memory last tep)
SM14LG / Ø 40 cm gold (ext. black) / steel spoon / metal braided cable / black dimmer/cable	€ 1.085,00										
SM14LC / Ø 40 cm copper (ext. black) / steel spoon / metal braided cable / black dimmer/cable	€ 1.085,00										
SM16LS / Ø 60 cm silver (ext. black) / steel spoons / metal braided cable / black dimmer/cable	€ 1.325,00										
SM16LG / Ø 60 cm gold (ext. black) / steel spoons / metal braided cable / black dimmer/cable	€ 1.325,00										
SM16LC / Ø 60 cm copper (ext. black) / steel spoons / metal braided cable / black dimmer/cable	€ 1.325,00										

p. 225

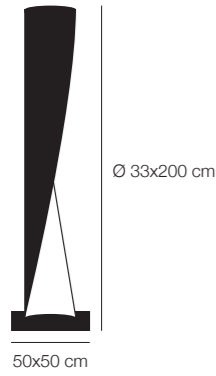

**Stchu-Moon 09** / standing lamp

	voltage	source	type	watt	lumen	K	CRI	en. class	driver/transformer	dimmer
SM9LS / silver (rough iron ext.) / steel spoons / metal braided cable / black dimmer/cable	110-240V	24V DC LED board (1x candle included)	LED board	2x3,9W 7,8W	840	2700	80	F	low voltage plug driver**	included (memory last step)
SM9LG / gold (rough iron ext.) / steel spoons / metal braided cable / black dimmer/cable										
SM9LC / copper (rough iron ext.) / steel spoons / metal braided cable / black dimmer/cable										

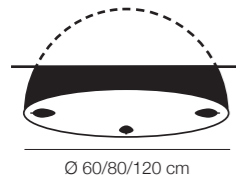

**Stchu-Moon SR** / semi-recessed lamp for plasterboard ceiling

	voltage	source	type	watt	lumen	K	CRI	en. class	driver/transformer	dimming
SMSI6BG / Ø 60 cm gold (ext. black) / steel spoon	-	24V DC LED board	LED board	3x3,9W 11,7W	1260	2700	80	F	not included available on request	-
SMSI8BG / Ø 80 cm gold (ext. black) / steel spoon				4x3,9W 15,6W						
SMSI12BG / Ø 120 cm gold (ext. black) / steel spoon										

Silver and copper finish available on request.

Ø 60 cm: hole Ø 52 cm / max depth 15 cm  
 Ø 80 cm: hole Ø 69 cm / max depth 20 cm  
 Ø 120 cm: hole Ø 104 cm / max depth 30 cm

**Macchina della Luce**

[ Finishes ] // **Nickel coating** (metal plating process) is chosen by the designer for its elegant and warm finish. To prevent any natural oxidation process, it requires regular cleaning. In alternative to nickel coating, customized finishes (i.e. chrome plating) can be provided upon request. / **Untreated brass** (an alloy of copper and zinc) is a very elegant finish, yellow-gold in colour, with an excellent corrosion resistance. We use it untreated, therefore it may oxidise with time. Regular cleaning helps preserving its original appearance and slow down the ageing process, which might be anyway accelerated by the weather, frequent handling or conditions of high humidity.

[ Note ] // The **lumen** value refers to the rated lumen output of the light source; for the lamp's output please refer to our bim files (see website). / (\*) LED bulbs can be dimmed using compatible dimmers, which have been tested specifically for dimming very low loads. The manufacturers of LED bulbs are required to draw up a list of suggested dimmers for the dimming of their products, with an indication of the maximum number of bulbs dimmable with the various types of dimmer.

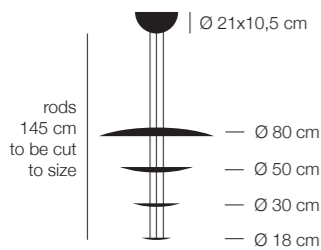

**Macchina della Luce mod. A** / pendant lamp

	voltage	source	type	watt	lumen	K	CRI	en. class	driver/transformer	dimming
MALG / discs Ø 80-50-30-18 cm / gold / nickel base / brass rods	220-240V	24V DC LED board	LED board	7x6W 42W	4410	2700	80	F	electronic 24V DC low voltage	YES Triac
MALS / discs Ø 80-50-30-18 cm / silver / nickel base / aluminium rods										
MALC / discs Ø 80-50-30-18 cm / copper / nickel base / brass rods										
MALG110V / discs Ø 80-50-30-18 cm / gold / nickel base / brass rods	110V	24V DC LED board	LED board	7x6W 42W	4410	2700	80	F	electronic 24V DC low voltage	YES Triac
MALS110V / discs Ø 80-50-30-18 cm / silver / nickel base / aluminium rods										
MALC110V / discs Ø 80-50-30-18 cm / copper / nickel base / brass rods										

weight 10 kg / rods 300 cm available on request

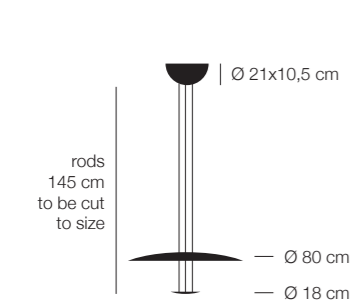

**Macchina della Luce mod. B / pendant lamp**

	voltage	source	type	watt	lumen	K	CRI	en. class	driver/transformer	dimming	
MBLG / discs Ø 80-18 cm / gold / nickel base / brass rods	220-240V	24V DC LED board	LED board	2x6W 12W	1260	2700	80	F	electronic 24V DC low voltage	YES Triac	
MBLS / discs Ø 80-18 cm / silver / nickel base / aluminium rods											€ 1.565,00
MBLC / discs Ø 80-18 cm / copper / nickel base / brass rods											€ 1.565,00
MBLG110V / discs Ø 80-18 cm / gold / nickel base / brass rods	110V	24V DC LED board	LED board	2x6W 12W	1260	2700	80	F	electronic 24V DC low voltage	YES Triac	
MBSL110V / discs Ø 80-18 cm / silver / nickel base / aluminium rods											€ 1.565,00
MBLC110V / discs Ø 80-18 cm / copper / nickel base / brass rods											€ 1.565,00

weight 6 kg / rods 300 cm available on request

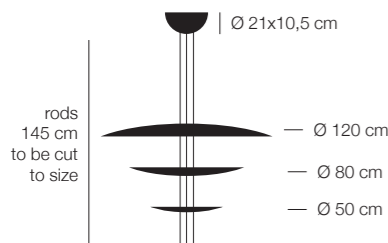
**Macchina della Luce mod. C / pendant lamp**

	voltage	source	type	watt	lumen	K	CRI	en. class	driver/transformer	dimming	
MCLG / discs Ø 120 (flying leaf)-80-50 cm / gold / nickel base / brass rods	220-240V	24V DC LED board	LED board	7x6W 42W	4410	2700	80	F	electronic 24V DC low voltage	YES Triac	
MCLS / discs Ø 120 (flying leaf)-80-50 cm / silver / nickel base / aluminium rods											€ 3.030,00
MCLC / discs Ø 120 (flying leaf)-80-50 cm / copper / nickel base / brass rods											€ 3.030,00
MCLG110V / discs Ø 120 (flying leaf)-80-50 cm / gold / nickel base / brass rods	110V	24V DC LED board	LED board	7x6W 42W	4410	2700	80	F	electronic 24V DC low voltage	YES Triac	
MCLS110V / discs Ø 120 (flying leaf)-80-50 cm / silver / nickel base / aluminium rods											€ 3.030,00
MCLC110V / discs Ø 120 (flying leaf)-80-50 cm / copper / nickel base / brass rods											€ 3.030,00

weight 13 kg / rods 300 cm available on request

p. 231

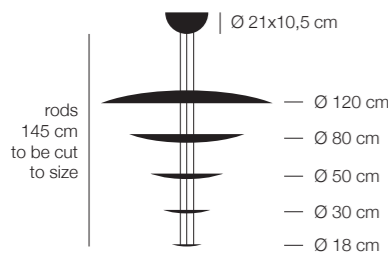
**Macchina della Luce mod. D / pendant lamp**

	voltage	source	type	watt	lumen	K	CRI	en. class	driver/transformer	dimming	
MDLG / discs Ø 120 (flying leaf)-80-50-30-18 cm / gold / nickel base / brass rods	220-240V	24V DC LED board	LED board	10x6W 60W	6300	2700	80	F	electronic 24V DC low voltage	YES Triac	
MDLS / discs Ø 120 (flying leaf)-80-50-30-18 cm / silver / nickel base / aluminium rods											€ 3.460,00
MDLC / discs Ø 120 (flying leaf)-80-50-30-18 cm / copper / nickel base / brass rods											€ 3.460,00
MDLG110V / discs Ø 120 (flying leaf)-80-50-30-18 cm / gold / nickel base / brass rods	110V	24V DC LED board	LED board	8x6W 48W	5040	2700	80	F	electronic 24V DC low voltage	YES Triac	
MDLS110V / discs Ø 120 (flying leaf)-80-50-30-18 cm / silver / nickel base / aluminium rods											€ 3.460,00
MDLC110V / discs Ø 120 (flying leaf)-80-50-30-18 cm / copper / nickel base / brass rods											€ 3.460,00

weight 16 kg / rods 300 cm available on request

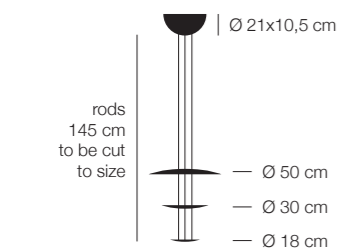
**Macchina della Luce mod. E / pendant lamp**

	voltage	source	type	watt	lumen	K	CRI	en. class	driver/transformer	dimming	
MELG / discs Ø 50-30-18 cm / gold / nickel base / brass rods	220-240V	24V DC LED board	LED board	4x6W 24W	2520	2700	80	F	electronic 24V DC low voltage	YES Triac	
MELS / discs Ø 50-30-18 cm / silver / nickel base / aluminium rods											€ 1.535,00
MELC / discs Ø 50-30-18 cm / copper / nickel base / brass rods											€ 1.535,00
MELG110V / discs Ø 50-30-18 cm / gold / nickel base / brass rods	110V	24V DC LED board	LED board	4x6W 24W	2520	2700	80	F	electronic 24V DC low voltage	YES Triac	
MELS110V / discs Ø 50-30-18 cm / silver / nickel base / aluminium rods											€ 1.535,00
MELC110V / discs Ø 50-30-18 cm / copper / nickel base / brass rods											€ 1.535,00

weight 6 kg / rods 300 cm available on request

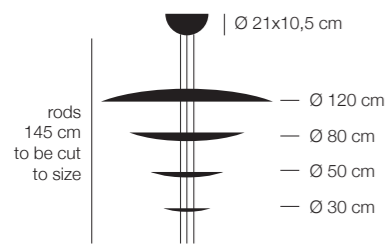

## Macchina della Luce mod. F / pendant lamp

	voltage	source	type	watt	lumen	K	CRI	en. class	driver/transformer	dimming
MFLG / discs Ø 120 (flying leaf)-80-50-30 cm / gold / nickel base / brass rods	220-240V	24V DC LED board	LED board	9x6W 54W	5670	2700	80	F	electronic 24V DC low voltage	YES Triac
MFLS / discs Ø 120 (flying leaf)-80-50-30 cm / silver / nickel base / aluminium rods										
MFLC / discs Ø 120 (flying leaf)-80-50-30 cm / copper / nickel base / brass rods										
MFLG110V / discs Ø 120 (flying leaf)-80-50-30 cm / gold / nickel base / brass rods	110V	24V DC LED board	LED board	8x6W 48W	5040	2700	80	F	electronic 24V DC low voltage	YES Triac
MFLS110V / discs Ø 120 (flying leaf)-80-50-30 cm / silver / nickel base / aluminium rods										
MFLC110V / discs Ø 120 (flying leaf)-80-50-30 cm / copper / nickel base / brass rods										

weight 15 kg / rods 300 cm available on request

p. 232

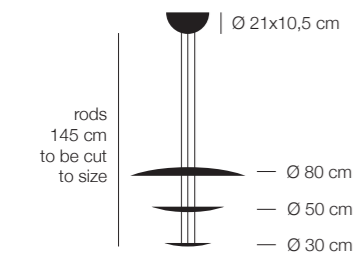

## Macchina della Luce mod. I / pendant lamp

	voltage	source	type	watt	lumen	K	CRI	en. class	driver/transformer	dimming
MILG / discs Ø 80-50-30 cm / gold / nickel base / brass rods	220-240V	24V DC LED board	LED board	5x6W 30W	3150	2700	80	F	electronic 24V DC low voltage	YES Triac
MILS / discs Ø 80-50-30 cm / silver / nickel base / aluminium rods										
MILC / discs Ø 80-50-30 cm / copper / nickel base / brass rods										
MILG110V / discs Ø 80-50-30 cm / gold / nickel base / brass rods	110V	24V DC LED board	LED board	5x6W 30W	3150	2700	80	F	electronic 24V DC low voltage	YES Triac
MILS110V / discs Ø 80-50-30 cm / silver / nickel base / aluminium rods										
MILC110V / discs Ø 80-50-30 cm / copper / nickel base / brass rods										

weight 8 kg / rods 300 cm available on request

## Luci d'Oro

[ *Finishes* ] // **Nickel coating** (metal plating process) is chosen by the designer for its elegant and warm finish. To prevent any natural oxidation process, it requires regular cleaning. In alternative to nickel coating, customized finishes (i.e. chrome plating) can be provided upon request. / **Untreated brass** (an alloy of copper and zinc) is a very elegant finish, yellow-gold in colour, with an excellent corrosion resistance. We use it untreated, therefore it may oxidise with time. Regular cleaning helps preserving its original appearance and slow down the ageing process, which might be anyway accelerated by the weather, frequent handling or conditions of high humidity. / **Rough iron** (untreated metal) is chosen by the designer specifically because of its uniqueness and its natural ageing property. The appearance of any uneven rust patches does not constitute a defect, since it is a typical sign of the ageing process, which might be considerably accelerated in conditions of high humidity or direct exposure to outdoor weathering.

[ *Note* ] // The **lumen** value refers to the rated lumen output of the light source; for the lamp's output please refer to our bim files (see website). / ( **\*** ) LED bulbs can be dimmed using compatible dimmers, which have been tested specifically for dimming very low loads. The manufacturers of LED bulbs are required to draw up a list of suggested dimmers for the dimming of their products, with an indication of the maximum number of bulbs dimmable with the various types of dimmer. / ( **\*\*** ) Our LEDs can be dimmed by using compatible dimmers tested specifically to dim very low loads. We suggest checking the minimum load of the dimmer before installation.

p. 237

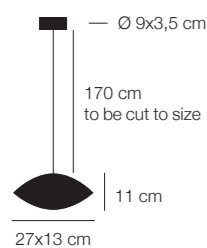

## Malagola 27 / pendant lamp

	voltage	source	type	watt	lumen	K	CRI	en. class	driver/transformer	dimming
ML27LG / gold / black base and cable	110-240V	constant current LED	COB LED	1x2W	300	2700	>80	F	constant current driver	NO
ML27LS / silver / black base and cable										
ML27LC / copper / black base and cable										

weight 0,9 kg

p. 237

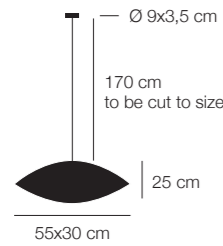

**Malagola 55 / pendant lamp**

- ML55LG / gold / black-cloth cable / black base
- ML55LS / silver / black-cloth cable / black base
- ML55LC / copper / black-cloth cable / black base

	voltage	source	type	watt	lumen	K	CRI	en. class	driver/transformer	dimming
ML55LG / gold / black-cloth cable / black base	110V (bulb not supplied)-240V	mains voltage LED	E27 bulb silver crowned	1x7W	600	2700	>80	F	-	YES IGBT/Triac*
ML55LS / silver / black-cloth cable / black base										
ML55LC / copper / black-cloth cable / black base										

weight 1,7 kg

p. 237

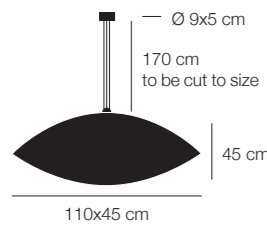

**Malagola 110 / pendant lamp**

- ML110LG / gold / black-cloth cable / black base
- ML110LS / silver / black-cloth cable / black base
- ML110LC / copper / black-cloth cable / black base

	voltage	source	type	watt	lumen	K	CRI	en. class	driver/transformer	dimming
ML110LG / gold / black-cloth cable / black base	110V (bulbs not supplied)-240V	mains voltage LED	E27 bulb silver crowned	3x7W 21W	1800	2700	>80	F	-	YES IGBT/Triac*
ML110LS / silver / black-cloth cable / black base										
ML110LC / copper / black-cloth cable / black base										

weight 4,5 kg

p. 239

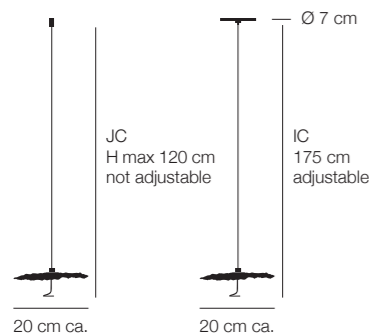

**Gold Moon JC / IC / recessed pendant lamp for plasterboard ceiling**

- GMJCLVO / mod. JC / nickel jack connection / black wire / black/gold wrap shade / copper curl € 265,00
- GMICLVO / mod. IC / nickel plate with tensioner / black wire / black/gold wrap shade / copper curl € 255,00

	voltage	source	type	watt	lumen	K	CRI	en. class	driver/transformer	dimming
GMJCLVO / mod. JC / nickel jack connection / black wire / black/gold wrap shade / copper curl	-	constant voltage 24V LED	LED Jack/interch.	1x1,1W	63	2700	>80	G	not included available on request	-
GMICLVO / mod. IC / nickel plate with tensioner / black wire / black/gold wrap shade / copper curl			interch. LED							

installation hole mod. JC Ø 1,3 cm  
 installation hole mod. IC Ø 5,5 cm  
 max plasterboard thickness 12,5 mm

p. 242

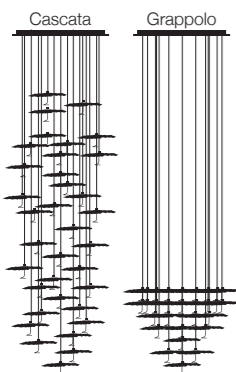

**Gold Moon Chandelier / pendant lamp**

**Cascata**

- CGM20CLVO / satin steel base / 20x black/gold wrap shades / copper curls / nickel jack / black wires € 6.000,00
- CGM25CLVO / satin steel base / 25x black/gold wrap shades / copper curls / nickel jack / black wires € 7.500,00
- CGM35CLVO / satin steel base / 35x black/gold wrap shades / copper curls / nickel jack / black wires € 10.500,00

**Grappolo**

- CGM20CLVOG / satin steel base / 20x black/gold wrap shades / copper curls / nickel jack / black wires € 6.000,00
- CGM25CLVOG / satin steel base / 25x black/gold wrap shades / copper curls / nickel jack / black wires € 7.500,00
- CGM35CLVOG / satin steel base / 35x black/gold wrap shades / copper curls / nickel jack / black wires € 10.500,00

	voltage	source	type	watt	lumen	K	CRI	en. class	driver/transformer	dimming
CGM20CLVO / satin steel base / 20x black/gold wrap shades / copper curls / nickel jack / black wires	110V or 240V	constant voltage 24V LED	LED Jack/interch.	20x1,1W 22W	1260	2700	90	G	constant voltage driver	YES IGBT/Triac**
CGM25CLVO / satin steel base / 25x black/gold wrap shades / copper curls / nickel jack / black wires				25x1,1W 27,5W	1575					
CGM35CLVO / satin steel base / 35x black/gold wrap shades / copper curls / nickel jack / black wires				35x1,1W 37,5W	2205					
CGM20CLVOG / satin steel base / 20x black/gold wrap shades / copper curls / nickel jack / black wires	110V or 240V	constant voltage 24V LED	LED Jack/interch.	20x1,1W 22W	1260	2700	90	G	constant voltage driver	YES IGBT/Triac**
CGM25CLVOG / satin steel base / 25x black/gold wrap shades / copper curls / nickel jack / black wires				25x1,1W 27,5W	1575					
CGM35CLVOG / satin steel base / 35x black/gold wrap shades / copper curls / nickel jack / black wires				35x1,1W 38,5W	2205					

Further base dimensions and finish (ie. white/silver - black/silver shades) available.

base Ø 78 cm / shades Ø 20 cm ca. /  
 H max 300 cm not adjustable

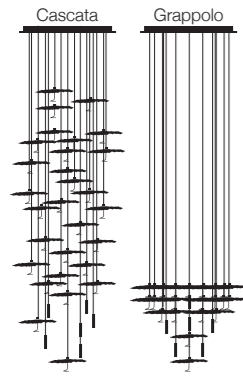

base Ø 78 cm / shades Ø 20 cm ca. /  
H max 300 cm not adjustable

**Gold Moon Chandelier with Spot Light / pendant lamp**

**Cascata**

CGMSPL20CLVO / satin steel base / 17x GM / 3x SPL / copper curls / nickel jack / black wires	€ 6.210,00
CGMSPL25CLVO / satin steel base / 22x GM / 3x SPL / copper curls / nickel jack / black wires	€ 7.710,00
CGMSPL35CLVO / satin steel base / 29x GM / 6x SPL / copper curls / nickel jack / black wires	€ 10.920,00

**Grappolo**

CGMSPL20CLVOG / satin steel base / 17x GM / 3x SPL / copper curls / nickel jack / black wires	€ 6.210,00
CGMSPL25CLVOG / satin steel base / 22x GM / 3x SPL / copper curls / nickel jack / black wires	€ 7.710,00
CGMSPL35CLVOG / satin steel base / 29x GM / 6x SPL / copper curls / nickel jack / black wires	€ 10.920,00

GM= black/gold shades Ø 20 cm / SPL= black/brass Spot Light

Further base dimensions and finish (ie. white/silver - black/silver shades) available.

voltage	source	type	watt	lumen	K	CRI	en. class	driver/transformer	dimming
110V or 240V	constant voltage 24V LED	LED Jack/interch.	20x1,1W 22W	1260	2700	90	G	constant voltage driver	YES IGBT/Triac**
			25x1,1W 27,5W	1575					
			35x1,1W 38,5W	2205					

p. 248

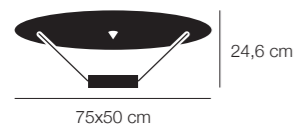

**DiscO / ceiling lamp**

DSOLG / gold / polished aluminium and nickel details	€ 885,00
DSOLS / silver / polished aluminium and nickel details	€ 885,00
DSOLC / copper / polished aluminium and nickel details	€ 885,00
DSOLW / white / polished aluminium and nickel details	€ 885,00

voltage	source	type	watt	lumen	K	CRI	en. class	driver/transformer	dimming
240V (available 110V DALI dimmable)	constant current LED	COB LED	1x15W	2187	2700	85	D	constant current LED driver	YES Triac

p. 249



**Luna W / wall lamp**

LNW30G / gold / copper stick / brass flex	€ 485,00
LNW30S / silver / copper stick / brass flex	€ 485,00
LNW30C / copper / copper stick / brass flex	€ 485,00

voltage	source	type	watt	lumen	K	CRI	en. class	driver/transformer	dimming
110V or 240V	constant current LED 350 mA	interch. LED	2x1W 2W	298	2700	85	D	constant current driver	NO

p. 250

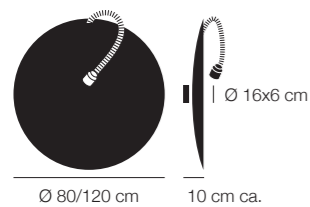

**Luna Piena 80 / 120 / ceiling or wall lamp**

LP80LG / Luna Piena 80 / gold flying leaf (exterior grey matt) / brass flex / white base	€ 1.095,00
LP80LS / Luna Piena 80 / silver flying leaf (exterior grey matt) / nickel flex / white base	€ 1.095,00
LP80LC / Luna Piena 80 / copper flying leaf (exterior grey matt) / brass flex / white base	€ 1.095,00
LP120LG / Luna Piena 120 / gold flying leaf (exterior grey matt) / brass flex / white base	€ 1.485,00
LP120LS / Luna Piena 120 / silver flying leaf (exterior grey matt) / nickel flex / white base	€ 1.485,00
LP120LC / Luna Piena 120 / copper flying leaf (exterior grey matt) / brass flex / white base	€ 1.485,00

voltage	source	type	watt	lumen	K	CRI	en. class	driver/transformer	dimming
220-240V (110V available on request)	low voltage LED 12V	GU5.3	1x7,5W	630	3000	90	F	low voltage driver	YES IGBT/Triac

H recommended distance from lamp to disc 25 cm ca  
Ø 80: flex Ø 1,3x50 cm  
Ø 120: flex Ø 1,5x80 cm

p. 253

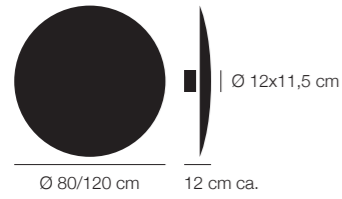

**Francesca 80 / 120 / wall lamp**

FR8230LWG / Francesca 80 / white/gold back side / white base	€	995,00
FR8230LG / Francesca 80 / gold / gold base	€	995,00
FR8230LS / Francesca 80 / silver / silver base	€	995,00
FR8230LC / Francesca 80 / copper / copper base	€	995,00
FR12230LWG / Francesca 120 / white/gold back side / white base	€	1.385,00
FR12230LG / Francesca 120 / gold / gold base	€	1.385,00
FR12230LS / Francesca 120 / silver / silver base	€	1.385,00
FR12230LC / Francesca 120 / copper / copper base	€	1.385,00

voltage	source	type	watt	lumen	K	CRI	en. class	driver/transformer	dimming
110V (bulbs not supplied)-240V	mains voltage LED	E27 LED bulb	8x8W 64W	7200	2700	>80	E	-	YES IGBT/Triac*

p. 254

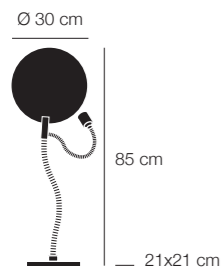

**Luce d'Oro T / table lamp**

LOLG / gold / brass flex / rough iron base / black switch and cable	€	680,00
LOLS / silver / nickel flex / rough iron base / black switch and cable	€	680,00
LOLC / copper / brass flex / rough iron base / black switch and cable	€	680,00

voltage	source	type	watt	lumen	K	CRI	en. class	driver/transformer	dimmer
110-240V	low voltage LED 12V	GU4 bulb	1x3,5W	200	2700	80	G	low voltage plug driver	NO on/off switch included

p. 255

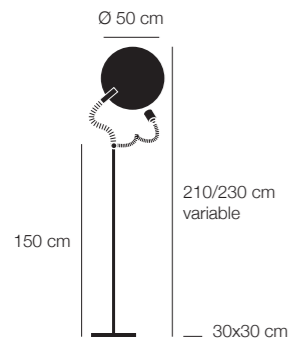

**Luce d'Oro F / standing lamp**

LOFLG / gold / brass flex / rough iron base and structure / black cable and dimmer	€	990,00
LOFLS / silver / nickel flex / rough iron base and structure / black cable and dimmer	€	990,00
LOFLC / copper / brass flex / rough iron base and structure / black cable and dimmer	€	990,00

voltage	source	type	watt	lumen	K	CRI	en. class	driver/transformer	dimmer
110-240V	low voltage LED 12V	GU5.3 bulb	1x7,5W	630	3000	90	F	low voltage plug driver	included (memory last step)

p. 256

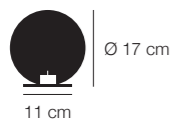

**Luna / table candle holder**

LNG / gold / rough iron base	€	175,00
LNS / silver / rough iron base	€	175,00
LNC / copper / rough iron base	€	175,00

voltage	source	type	watt	lumen	K	CRI	en. class	driver/transformer	dimming
-	candle (included)	-	-	-	-	-	-	-	-

p. 257

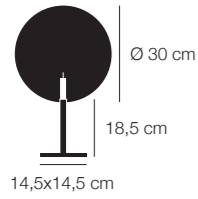
**Gemma** / table candle holder

		voltage	source	type	watt	lumen	K	CRI	en. class	driver/transformer	dimmer
GMG / gold / rough iron structure	€ 295,00	-	candle (included)	-	-	-	-	-	-	-	-
GMS / disc silver / rough iron structure	€ 295,00										
GMC / copper / rough iron structure	€ 295,00										

p. 258

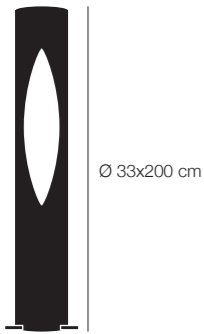
**Colonna** / standing lamp

		voltage	source	type	watt	lumen	K	CRI	en. class	driver/transformer	dimmer
CNLG / gold interior (flying leaf) / rough iron coloumn / black dimmer	€ 2.895,00	110V (bulb not supplied)-240V	mains voltage LED	E27 bulb	1x18W	1800	2700	>80	F	-	included (memory last step)
CNLS / silver interior (flying leaf) / rough iron coloumn / black dimmer	€ 2.895,00										
CNLC / copper interior (flying leaf) / rough iron coloumn / black dimmer	€ 2.895,00										

p. 261

**Pepita 65** / recessed lamp for plasterboard ceiling

		voltage	source	type	watt	lumen	K	CRI	en. class	driver/transformer	dimming
P65 / white / gold / transparent cover	€ 310,00	-	constant voltage 24V LED	interch. LED board	1x1W	160	2700	>80	F	not included available on request	-

internal Ø 5,9 cm / external Ø 8,9 cm  
depth 5,6 cm / installation hole Ø 6,5 cm  
max plasterboard thickness 12,5 mm

p. 262

**Pepita 102** / recessed lamp for plasterboard ceiling/wall

		voltage	source	type	watt	lumen	K	CRI	en. class	driver/transformer	dimming
P102 / white / gold	€ 365,00	-	constant voltage 24V LED	interch. LED board	1x1W	160	2700	>80	F	not included available on request	-

internal Ø 9,7 cm / external Ø 11 cm  
depth 5,5 cm / installation hole Ø 10,2 cm  
max plasterboard thickness 12,5 mm

# Turciù

[ *Finishes* ] // **Nickel coating** (metal plating process) is chosen by the designer for its elegant and warm finish. To prevent any natural oxidation process, it requires regular cleaning. In alternative to nickel coating, customized finishes (i.e. chrome plating) can be provided upon request. / **Untreated brass** (an alloy of copper and zinc) is a very elegant finish, yellow-gold in colour, with an excellent corrosion resistance. We use it untreated, therefore it may oxidise with time. Regular cleaning helps preserving its original appearance and slow down the ageing process, which might be anyway accelerated by the weather, frequent handling or conditions of high humidity. / **Rough iron** (untreated metal) is chosen by the designer specifically because of its uniqueness and its natural ageing property. The appearance of any uneven rust patches does not constitute a defect, since it is a typical sign of the ageing process, which might be considerably accelerated in conditions of high humidity or direct exposure to outdoor weathering.

[ *Note* ] // The **lumen** value refers to the rated lumen output of the light source; for the lamp's output please refer to our bim files (see website). / ( **\*** ) LED bulbs can be dimmed using compatible dimmers, which have been tested specifically for dimming very low loads. The manufacturers of LED bulbs are required to draw up a list of suggested dimmers for the dimming of their products, with an indication of the maximum number of bulbs dimmable with the various types of dimmer.

p. 267



90/160 cm variable

## Turciù 36 / ceiling/pendant lamp

		voltage	source	type	watt	lumen	K	CRI	en. class	driver/transformer	dimming
TRS36LNC / nickel flex (nickel lampholder) / satin nickel base	€ 3.350,00	110V (bulbs not supplied)-240V	mains voltage LED	E14 bulb	36x3,4W 122,4W	13680	2700	>80	E	-	YES IGBT/Triac*
TRS36LBR / brass flex (nickel lampholder) / satin nickel base	€ 3.450,00										

flex Ø 0,85 cm:  
7x75 cm / 10x100 cm / 9x125 cm / 10x150 cm  
weight 20 kg

p. 267



90/160 cm variable

## Turciù 21 / ceiling/pendant lamp

		voltage	source	type	watt	lumen	K	CRI	en. class	driver/transformer	dimming
TRS21LNC / nickel flex (nickel lampholder) / satin nickel base	€ 2.370,00	110V (bulbs not supplied)-240V	mains voltage LED	E14 bulb	21x3,4W 71,4W	7980	2700	>80	E	-	YES IGBT/Triac*
TRS21LBR / brass flex (nickel lampholder) / satin nickel base	€ 2.470,00										

flex Ø 0,85 cm: 5x100 cm / 16x150 cm  
weight 11 kg

p. 267

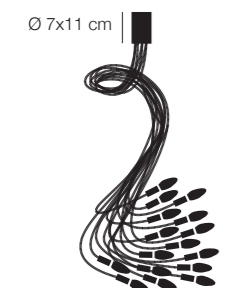

90/160 cm variable

## Turciù 16 / ceiling/pendant lamp

		voltage	source	type	watt	lumen	K	CRI	en. class	driver/transformer	dimming
TRS16LNC / nickel flex (nickel lampholder) / satin nickel base	€ 2.000,00	110V (bulbs not supplied)-240V	mains voltage LED	E14 bulb	16x3,4W 54,4W	6080	2700	>80	E	-	YES IGBT/Triac*
TRS16LBR / brass flex (nickel lampholder) / satin nickel base	€ 2.100,00										

flex Ø 0,85 cm: 16x150 cm  
weight 9 kg

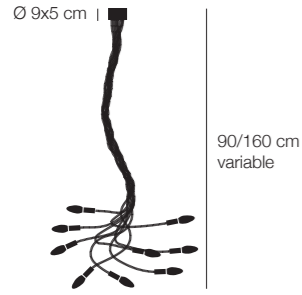

**Turciù 9 / ceiling/pendant lamp**

		voltage	source	type	watt	lumen	K	CRI	en. class	driver/transformer	dimming
TRS9LNC / nickel flex (nickel lampholder) / satin nickel base	€ 1.135,00	110V (bulbs not supplied)-240V	mains voltage LED	E14 bulb	9x3,4W 30,6W	3420	2700	>80	E	-	YES IGBT/Triac*
TRS9LBR / brass flex (nickel lampholder) / satin nickel base	€ 1.195,00										

flex Ø 0,85 cm: 9x150 cm  
weight 5 kg

p. 268

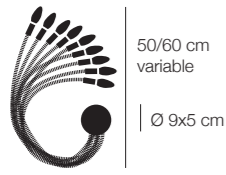

**Turciù 9 / wall lamp**

		voltage	source	type	watt	lumen	K	CRI	en. class	driver/transformer	dimming
TR9LNC / nickel flex (nickel lampholder) / satin nickel base	€ 955,00	110V (bulbs not supplied)-240V	mains voltage LED	E14 bulb	9x3,4W 30,6W	3420	2700	>80	E	-	YES IGBT/Triac*
TR9LBR / brass flex (nickel lampholder) / satin nickel base	€ 1.015,00										

flex Ø 0,85 cm: 9x75 cm

p. 269

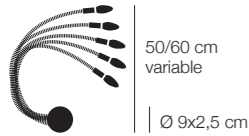

**Turciù 5 / wall lamp**

		voltage	source	type	watt	lumen	K	CRI	en. class	driver/transformer	dimming
TR5LNC / nickel flex (nickel lampholder) / nickel base	€ 525,00	110V (bulbs not supplied)-240V	mains voltage LED	E14 bulb	5x3,4W 17W	1900	2700	>80	E	-	YES IGBT/Triac*
TR5LBR / brass flex (nickel lampholder) / nickel base	€ 555,00										

flex Ø 0,85 cm: 5x75 cm

p. 270



**Turciù 3 / 2 / wall lamp**

		voltage	source	type	watt	lumen	K	CRI	en. class	driver/transformer	dimming
TR3LNC / Turciù 3 / nickel flex (nickel lampholder) / nickel base	€ 395,00	110V (bulbs not supplied)-240V	mains voltage LED	E14 bulb	3x3,4W 10,2W	1140	2700	>80	E	-	YES IGBT/Triac*
TR3LBR / Turciù 3 / brass flex (nickel lampholder) / nickel base	€ 400,00										



		voltage	source	type	watt	lumen	K	CRI	en. class	driver/transformer	dimming
TR2LNC / Turciù 2 /nickel flex (nickel lampholder) / nickel base	€ 330,00	110V (bulbs not supplied)-240V	mains voltage LED	E14 bulb	2x3,4W 6,8W	760	2700	>80	E	-	YES IGBT/Triac*
TR2LBR / Turciù 2 / brass flex (nickel lampholder) / nickel base	€ 335,00										

flex Ø 1,3 cm: 3/2x50 cm  
on request available with flex Ø 0,85 cm



p. 271

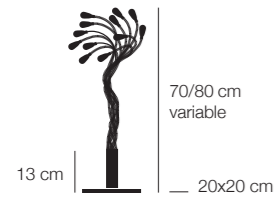

**Bonsai / table lamp**

BNLBR / LED / brass flex (nickel lampholder) / iron base / black cable and dimmer

€ 1.625,00

voltage	source	type	watt	lumen	K	CRI	en. class	driver/transformer	dimmer
240V (110V available on request / bulbs not supplied)	mains voltage LED	E14 bulb	12x2,7W 32,4W	1800	2700	>80	G	-	included

flex Ø 0,6 cm: 12x60 cm

p. 272

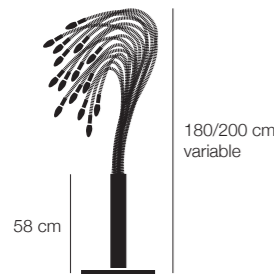

**Sottovento 15 / standing lamp**

SVLNC / nickel flex (nickel lampholder) / iron structure / black cable and dimmer

€ 4.190,00

SVLBR / brass flex (nickel lampholder) / iron structure / black cable and dimmer

€ 4.290,00

voltage	source	type	watt	lumen	K	CRI	en. class	driver/transformer	dimmer
240V (110V available on request / bulbs not supplied)	mains voltage LED	E14 bulb	15x3,4W 51W	5700	2700	>80	E	-	included

base 40x40 cm / flex Ø 1,2: 15x150 cm

p. 273

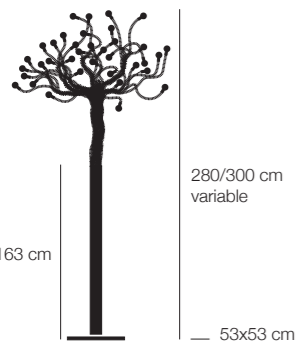

**Albero della Luce / standing lamp**

ALLBR / brass flex (nickel lampholder) / iron structure / black cable

€ 7.515,00

voltage	source	type	watt	lumen	K	CRI	en. class	driver/transformer	dimming
240V (110V available on request / bulbs not supplied)	mains voltage LED	E14 bulb	36x4W 144W	14400	2700	80	F	-	wireless (remote control included)

flex Ø 0,85 cm: 36x150 cm

## Oggetti Senza Tempo

[ Finishes ] // **Nickel coating** (metal plating process) is chosen by the designer for its elegant and warm finish. To prevent any natural oxidation process, it requires regular cleaning. In alternative to nickel coating, customized finishes (i.e. chrome plating) can be provided upon request. / **Untreated brass** (an alloy of copper and zinc) is a very elegant finish, yellow-gold in colour, with an excellent corrosion resistance. We use it untreated, therefore it may oxidise with time. Regular cleaning helps preserving its original appearance and slow down the ageing process, which might be anyway accelerated by the weather, frequent handling or conditions of high humidity. / **Copper** is a very malleable and ductile metal, chosen for its high thermal and electrical conductivity, as well as for its typical reddish-orange colour. We use it untreated, therefore it may oxidise with time, forming a green patina. Regular cleaning helps preserving its original appearance and slow down the ageing process, which might be anyway accelerated by the weather, frequent handling or conditions of high humidity.

[ Note ] // The **lumen** value refers to the rated lumen output of the light source; for the lamp's output please refer to our bim files (see website). / ( \* ) LED bulbs can be dimmed using compatible dimmers, which have been tested specifically for dimming very low loads. The manufacturers of LED bulbs are required to draw up a list of suggested dimmers for the dimming of their products, with an indication of the maximum number of bulbs dimmable with the various types of dimmer. / ( \*\* ) The plug driver 110-240V is supplied with the electrical plug suitable for the market of reference only. Please specify in stage of order if the destination of the product differs from your standard. / ( \*\*\* ) Our LEDs can be dimmed by using compatible dimmers tested specifically to dim very low loads. We suggest checking the minimum load of the dimmer before installation. / ( \*\*\*\* ) 220-240V version available with not interchangeable EU plug only - memory 100%.

p. 277

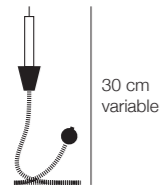

### Miracolo / table candle holder

MRBR / brass flex and details

€ 195,00

voltage	source	type	watt	lumen	K	CRI	en. class	driver/transformer	dimming
-	candle (included)	-	-	-	-	-	-	-	-

p. 278

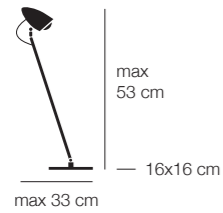

### CicloItalia T / table lamp

CIBR / brass base and structure / black dimmer / black wire

€ 1.210,00

voltage	source	type	watt	lumen	K	CRI	en. class	driver/transformer	dimmer
110-240V	constant current LED 500 mA	COB LED	1x5W	569	2700	>80	F	plug driver**	included

p. 279

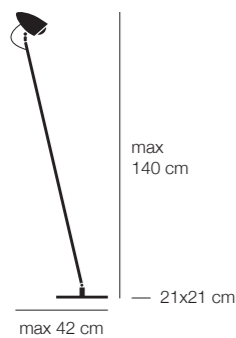

### CicloItalia F / standing lamp

CIFBR / black base / brass structure / black wire

€ 1.380,00

CIFBRM / black base / brass structure / black dimmer and wire

€ 1.380,00

voltage	source	type	watt	lumen	K	CRI	en. class	driver/transformer	dimmer
220-240V	constant current LED 350 mA	COB LED	1x5W	569	2700	>80	F	plug driver (EU plug only)	included touch (memory 100%)
110-240V								plug driver**	included (memory last step)

p. 283

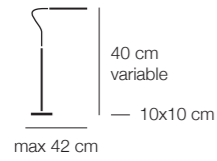

**Lola T / table lamp**

		voltage	source	type	watt	lumen	K	CRI	en. class	driver/transformer	dimmer
LBR / brass structure / copper stick / black wire / black dimmer	€ 890,00	110-240V	constant current LED 350 mA	interch. LED	3x1W 3W	447	2700	85	D	plug driver**	included (memory last step)

p. 285

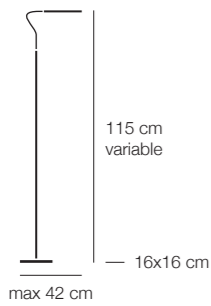

**Lola F / standing lamp**

		voltage	source	type	watt	lumen	K	CRI	en. class	driver/transformer	dimmer
LFBR / brass structure / copper stick / black wire	€ 1.060,00	220-240V	constant current LED 350 mA	interch. LED	3x1W 3W	447	2700	85	D	plug driver (EU plug only)	included touch (memory 100%)
LFBRM / brass structure / copper stick / black dimmer and wire	€ 1.060,00	110-240V								plug driver**	included (memory last step)

p. 286

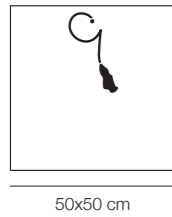

**Luce che dipinge / wall lamp**

		voltage	source	type	watt	lumen	K	CRI	en. class	driver/transformer	dimming
LD5L / white canvas / black pipe / black wrap screen	€ 995,00	240V (110V available on request)	12V DC LED bulb	G4 bulb	1x0,8W	69	2700	80	G	low voltage driver	NO

p. 288

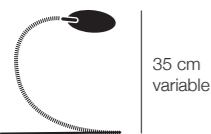

**Herem T / USB table lamp**

		voltage	source	type	watt	lumen	K	CRI	en. class	driver/transformer	dimming
HRT / brass flex and shade	€ 475,00	110-240V	constant voltage LED 5V	LED board	1x2,8W	300	2700	>90	D	USB plug driver 5V (EU or UK plug only)	included touch-less

p. 289

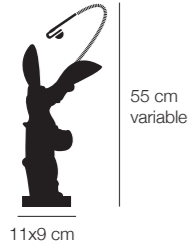

**Nike** / table lamp

		voltage	source	type	watt	lumen	K	CRI	en. class	driver/transformer	dimmer
NKL / white ceramic chalk statue / nickel flex / glass lens / blue wire / black dimmer	€ 1.275,00	110-240V****	constant current LED 350 mA	interch. LED	1x1W	149	2700	85	D	plug driver*****	included (memory last step)

p. 290

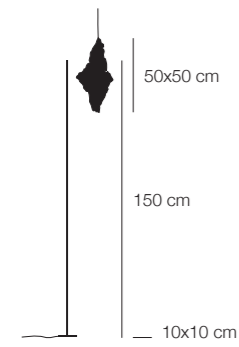

**Shadow** / standing lamp with net

		voltage	source	type	watt	lumen	K	CRI	en. class	driver/transformer	dimmer
SW / black structure / brass net / black wire and dimmer	€ 1.025,00	110-240V	constant current LED 350 mA	interch. LED	1x1W	149	2700	85	D	constant current plug driver**	included (memory last step)

p. 293



**EC 301** / wall or ceiling lamp

		voltage	source	type	watt	lumen	K	CRI	en. class	driver/transformer	dimming
EC301JB / black structure and base / brass joint and lens holder / glass lens	€ 395,00	220-240V	constant current LED 500 mA	COB LED	1x5W 5W	569	2700	>80	F	constant current driver	YES IGBT/Triac***
EC301JW / white structure and base / brass joint and lens holder / glass lens	€ 395,00										

p. 295

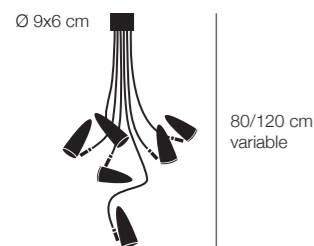

**CicloItalia Flex C6** / ceiling/pendant lamp

		voltage	source	type	watt	lumen	K	CRI	en. class	driver/transformer	dimming
CIC6B / black base and spotlights / brass flex and details / glass lens	€ 3.200,00	220-240V (110V available on request)	low voltage LED 12V	GU 5.3 bulb	6x7,5W 45W	3780	3000	90	F	low voltage LED transformer	YES Triac*
CIC6W / white base and spotlights / brass flex and details / glass lens	€ 3.200,00										

flex: 5x Ø1,3x50 cm; 1x Ø1,2x100 cm

p. 296



**CicloItalia Flex W1 / wall lamp**

		voltage	source	type	watt	lumen	K	CRI	en. class	driver/transformer	dimming
CIW1B / black base and spotlight / brass flex and details / glass lens / with on/off	€ 675,00	220-240V (110V available on request)	low voltage LED 12V	GU 5.3 bulb	1x7,5W	630	3000	90	F	low voltage LED transformer	NO on/off switch
CIW1W / white base and spotlight / brass flex and details / glass lens / with on/off	€ 675,00										

base: 17x5x4 cm ca.

p. 297

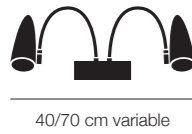

**CicloItalia Flex W2 / wall lamp**

		voltage	source	type	watt	lumen	K	CRI	en. class	driver/transformer	dimming
CIW2B / black base and spotlights / brass flex and details / glass lens	€ 1.000,00	220-240V (110V available on request)	low voltage LED 12V	GU 5.3 bulb	2x7,5W 15W	1260	3000	90	F	low voltage LED transformer	YES Triac*
CIW2W / white base and spotlights / brass flex and details / glass lens	€ 1.000,00										

base: 17x5x4 cm ca.

p. 298

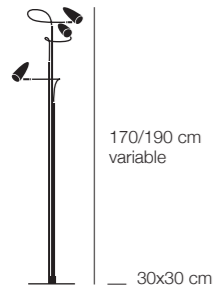

**CicloItalia Flex F3 / standing lamp**

		voltage	source	type	watt	lumen	K	CRI	en. class	driver/transformer	dimmer
CIF3BM / black rod/base/spotlights / brass flex and details / glass lens	€ 2.330,00	110-240V	low voltage LED 12V	GU 5.3 bulb	3x7,5W 22,5W	1890	3000	90	F	plug driver**	included (memory last step)
CIF3WM / white rod/base/spotlights / brass flex and details / glass lens	€ 2.330,00										

p. 301

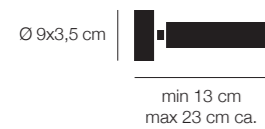

**U. W / wall lamp**

		voltage	source	type	watt	lumen	K	CRI	en. class	driver/transformer	dimmer
UWJB / black base and shade / brass joint	€ 465,00	220-240V (110V available on request)	constant current LED 270 mA	COB LED	1x9W	1324	2700	>80	E	constant current driver	YES IGBT/Triac***
UWJW / white base and shade / brass joint	€ 465,00										

p. 303

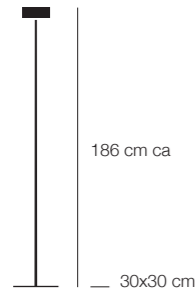

**U. F Up** / standing lamp

UFUB / black rod/base/shade (internally gold) / steel silhouette with magnet  
 UFUW / white rod/base/shade (internally gold) / steel silhouette with magnet

€ 1.175,00  
 € 1.175,00

voltage	source	type	watt	lumen	K	CRI	en. class	driver/transformer	dimmer
110-240V	constant current LED 500 mA	COB LED	1x17W	2500	2700	>80	D	plug driver**	included (memory last step)

p. 305

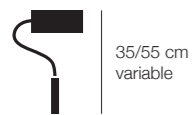

**U. W Flex** / wall lamp

UWFB / black base and shade / brass flex  
 UFWW / white base and shade / brass flex

€ 620,00  
 € 620,00

voltage	source	type	watt	lumen	K	CRI	en. class	driver/transformer	dimming
220-240V (110V available on request)	constant current LED 450 mA	COB LED	1x15W	2200	2700	>80	D	constant current driver	YES Triac***

base:16x3x6 cm

p. 307

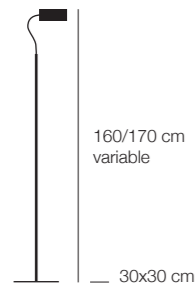

**U. F Flex** / standing lamp

UFFB / black base and shade / brass flex  
 UFFW / white base and shade / brass flex

€ 1.075,00  
 € 1.075,00

voltage	source	type	watt	lumen	K	CRI	en. class	driver/transformer	dimmer
110-240V	constant current LED 450 mA	COB LED	1x15W	2200	2700	>80	D	plug driver**	included (memory last step)

p. 309

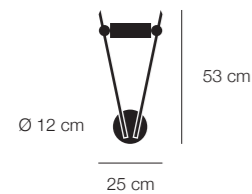

**Vi. W** / wall lamp

VIWB / black structure and shade / brass details  
 VIWW / white structure and shade / brass details

€ 925,00  
 € 925,00

voltage	source	type	watt	lumen	K	CRI	en. class	driver/transformer	dimming
220-240V (110V available on request)	constant current LED 450 mA	COB LED	1x15W	2200	2700	>80	D	constant current driver	YES Triac***

p. 311

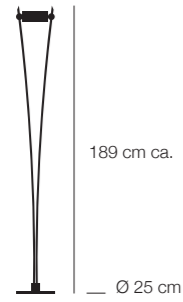

Vi. F / standing lamp

VIFB / black structure and shade / brass details	€	1.700,00
VIFW / white structure and shade / brass details	€	1.700,00

voltage	source	type	watt	lumen	K	CRI	en. class	driver/transformer	dimmer
110-240V	constant current LED 450 mA	COB LED	1x15W	2200	2700	>80	D	plug driver**	included (memory last step)

### Other Smiths

[ Finishes ] // **Untreated brass** (an alloy of copper and zinc) is a very elegant finish, yellow-gold in colour, with an excellent corrosion resistance. We use it untreated, therefore it may oxidise with time. Regular cleaning helps preserving its original appearance and slow down the ageing process, which might be anyway accelerated by the weather, frequent handling or conditions of high humidity.

[ Note ] // The **lumen** value refers to the rated lumen output of the light source; for the lamp's output please refer to our bim files (see website). / ( \* ) The plug driver 110-240V is supplied with the electrical plug suitable for the market of reference only. Please specify in stage of order if the destination of the product differs from your standard.

p. 315

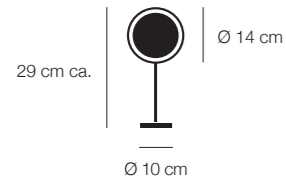

Talismano / table lamp

TLST / brass/iridescent glass / black dimmer and wire	€	1.495,00
---	---	----------

voltage	source	type	watt	lumen	K	CRI	en. class	driver/transformer	dimmer
110-240V	constant voltage 24V LED	LED flexible board	6W	2187	2700	>80	D	plug driver*	included (memory last step)

p. 319

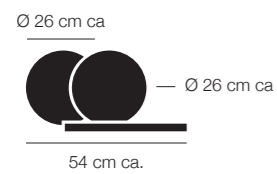

Alchemie T / table lamp

AHT / brass disc / alabaster diffuser / Medea limestone base	€	3.155,00
--	---	----------

voltage	source	type	watt	lumen	K	CRI	en. class	driver/transformer	dimmer
110-240V	constant voltage 24V LED	low voltage LED strip	12W	1300	3000	90	G	plug driver*	included

## Medousê (outdoor)

[ Finishes ] // **Untreated brass** (an alloy of copper and zinc) is a very elegant finish, yellow-gold in colour, with an excellent corrosion resistance. We use it untreated, therefore it may oxidise with time. Regular cleaning helps preserving its original appearance and slow down the ageing process, which might be anyway accelerated by the weather, frequent handling or conditions of high humidity.

[ Note ] // The **lumen** value refers to the rated lumen output of the light source; for the lamp's output please refer to our bim files (see website). / ( \* ) Mains voltage LED modules and COB LED are dimmable using IGBT (trailing edge) dimmers designed specifically for LED sources. Their dimming is extremely delicate: incompatible dimmers may cause irreparable damage to the LED. Some dimmers on the market have a NO button (Normally Open) or are specific connector socket-mounted or recessed. They are generally inserted into junction boxes; their limited thickness facilitates the installer's task and makes the dimmer fit for installation even in shallow boxes. Dimmers with an integrated radio dimmer for both manual (NO button) and wireless control are also available. It is important to note that during adjustment the dimming appears less precise, with some flickering. Furthermore some types of dimmer, even if they have been recommended by the manufacturers themselves, have visible flickering (almost essentially down to a minimum) depending on the mains and on the type of interference present. The problem can be solved by increasing the minimum value setting of the potentiometer on the dimmer. / ( \*\* ) IP specifics: LED module IP64; IP average rate of the lamp 44. / ( \*\*\* ) The LED modules provided for Medousê F and W have a starting temperature of 2.700K, as indicated in the manufacturer's datasheets. For their outdoor use, a protective resin is applied, which increases the temperature by 500K (CCT - correlated color temperature), reaching approximately 3.200K. Currently, it is not possible to provide a color temperature different from this.

p. 329

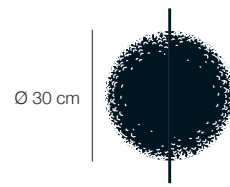

### Medousê W / wall lamp

		voltage	source	type	watt	lumen	K	CRI	en. class	driver/transformer	dimming
MD3P / green glass / brass rod	€ 805,00	110V or 240V	mains voltage LED**	LED module IP64	1x17W	1650	3200***	80	A+	-	YES*
MD3PTR / transparent glass / brass rod	€ 805,00										

p. 330



### Medousê F / floor lamp

		voltage	source	type	watt	lumen	K	CRI	en. class	driver/transformer	dimming
MD3 / Ø 30 cm / green glass / aluminium details / plug cable not included	€ 1.335,00	110V or 240V	mains voltage LED**	LED module IP64	1x25W	2875	3200***	80	E	-	YES*
MD3TR / Ø 30 cm / transparent glass / aluminium details / plug cable not included	€ 1.335,00										
MD5 / Ø 50 cm / green glass / aluminium details / plug cable not included	€ 2.055,00										
MD5TR / Ø 50 cm / transparent glass / aluminium details / plug cable not included	€ 2.055,00										

weight: Ø 30 cm 15 kg / Ø 50 cm 31 kg



More  
(outdoor)

[ Finishes ] // **Zinc plated steel** is the material of the stems of the More collection. They are suitable for outdoor installation, but they are not immersion proof. / **Untreated brass** (an alloy of copper and zinc) is a very elegant finish, yellow-gold in colour, with an excellent corrosion resistance. We use it untreated, therefore it may oxidise with time. Regular cleaning helps preserving its original appearance and slow down the ageing process, which might be anyway accelerated by the weather, frequent handling or conditions of high humidity.

[ Cables ] // ( **s** ) suspension cable. / ( **el** ) electrical cable.

[ Note ] // The **lumen** value refers to the rated lumen output of the light source; for the lamp's output please refer to our bim files (see website). / ( \* ) IP specifics: lampholder IP65 (not protected against immersion); wires IP68.

p. 334

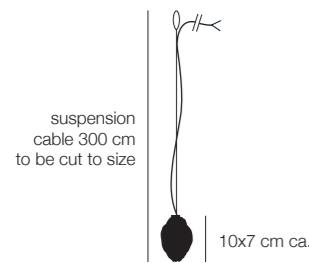

More / pendant lamp / driver and accessories not incl. (see pages 110-115)

		voltage	source	type	watt	lumen	K	CRI	en. class	driver/transformer	dimming
MRS / transparent glass / steel cable <sup>(s)</sup> / grey-transparent cable <sup>(el)</sup>	€ 405,00	-	12V DC LED bulb	G4 bulb (IP65 lampholder)*	1x0,8W	69	2700	80	G	not included available on request	-
MRSA / amber glass / steel cable <sup>(s)</sup> / grey-transparent cable <sup>(el)</sup>	€ 435,00										
MRSGR / green glass / steel cable <sup>(s)</sup> / grey-transparent cable <sup>(el)</sup>	€ 435,00										

weight 1 kg

p. 337

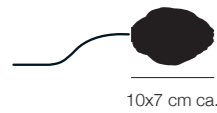

More 0 / floor lamp / driver and accessories not incl. (see pages 110-115)

		voltage	source	type	watt	lumen	K	CRI	en. class	driver/transformer	dimming
MR0 / transparent glass / grey-transparent cable 300 cm	€ 380,00	-	12V DC LED bulb	G4 bulb (IP65 lampholder)*	1x0,8W	69	2700	80	G	not included available on request	-
MR0A / amber glass / grey-transparent cable 300 cm	€ 410,00										
MR0GR / green glass / grey-transparent cable 300 cm	€ 410,00										

p. 338

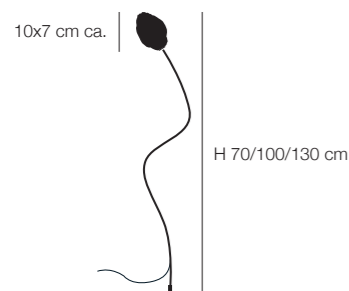

More F / standing lamp / driver and accessories not incl. (see pages 110-115)

		voltage	source	type	watt	lumen	K	CRI	en. class	driver/transformer	dimming
MR70 / H 70 cm / steel stem / transparent glass / grey-transparent cable 210 cm	€ 500,00	-	12V DC LED bulb	G4 bulb (IP65 lampholder)*	1x0,8W	69	2700	80	G	not included available on request	-
MR70A / H 70 cm / steel stem / amber glass / grey-transparent cable 210 cm	€ 530,00										
MR70GR / H 70 cm / steel stem / green glass / grey-transparent cable 210 cm	€ 530,00										
MR100 / H 100 cm / steel stem / transparent glass / grey-transparent cable 170 cm	€ 510,00										
MR100A / H 100 cm / steel stem / amber glass / grey-transparent cable 170 cm	€ 540,00										
MR100GR / H 100 cm / steel stem / green glass / grey-transparent cable 170 cm	€ 540,00										
MR130 / H 130 cm / steel stem / transparent glass / grey-transparent cable 150 cm	€ 520,00										
MR130A / H 130 cm / steel stem / amber glass / grey-transparent cable 150 cm	€ 550,00										
MR130GR / H 130 cm / steel stem / green glass / grey-transparent cable 150 cm	€ 550,00										

# Sypha (outdoor)

[ *Finishes* ] // **Stems** - the stems of the Sypha collection are made of brass (Syphaduepassi) or black coloured iron (Syphasera and Syphasfera). / **Untreated brass** (an alloy of copper and zinc) is a very elegant finish, yellow-gold in colour, with an excellent corrosion resistance. We use it untreated, therefore it may oxidise with time. Regular cleaning helps preserving its original appearance and slow down the ageing process, which might be anyway accelerated by the weather, frequent handling or conditions of high humidity.

[ *Note* ] // The **lumen** value refers to the rated lumen output of the light source; for the lamp's output please refer to our bim files (see website). / **(\*)** IP specifics: lampholder IP65 (not protected against immersion); wires and connectors IP68.

p. 343

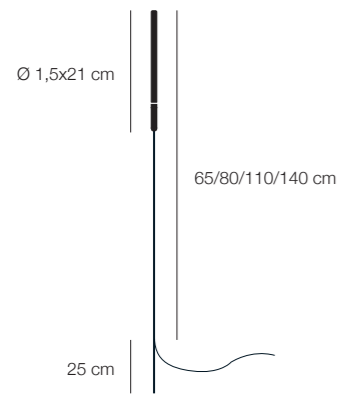

**Syphasera** / standing lamp / driver and accessories not incl. (see pages 110-115)

SYS65 / H 65 cm / black stem / brass details / opaline glass / grey-transparent cable 255 cm	€	260,00
SYS80 / H 80 cm / black stem / brass details / opaline glass / grey-transparent cable 240 cm	€	265,00
SYS110 / H 110 cm / black stem / brass details / opaline glass / grey-transparent cable 210 cm	€	275,00
SYS140 / H 140 cm / black stem / brass details / opaline glass / grey-transparent cable 180 cm	€	285,00

voltage	source	type	watt	lumen	K	CRI	en. class	driver/transformer	dimming
-	12V DC LED bulb	G4 bulb (IP65 lampholder)*	1x0,8W	67	2700	80	F	not included available on request	-

p. 346

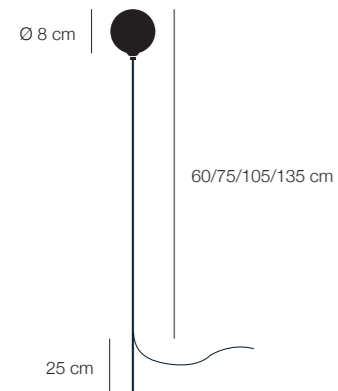

**Syphasfera** / standing lamp / driver and accessories not incl. (see pages 110-115)

SYF60 / H 60 cm / black stem / brass details / transparent glass / grey-transparent cable 255 cm	€	275,00
SYF60I / H 60 cm / black stem / brass details / irreg. transp. glass / grey-transparent cable 255 cm	€	275,00
SYF75 / H 75 cm / black stem / brass details / transparent glass / grey-transparent cable 240 cm	€	280,00
SYF75I / H 75 cm / black stem / brass details / irreg. transp. glass / grey-transparent cable 240 cm	€	280,00
SYF105 / H 105 cm / black stem / brass details / transparent glass / grey-transparent cable 210 cm	€	290,00
SYF105I / H 105 cm / black stem / brass details / irreg. transp. glass / grey-transparent cable 210 cm	€	290,00
SYF135 / H 135 cm / black stem / brass details / transparent glass / grey-transparent cable 180 cm	€	300,00
SYF135I / H 135 cm / black stem / brass details / irreg. transp. glass / grey-transparent cable 180 cm	€	300,00

voltage	source	type	watt	lumen	K	CRI	en. class	driver/transformer	dimming
-	12V DC LED bulb	G4 bulb (IP65 lampholder)*	1x0,8W	69	2700	80	G	not included available on request	-

p. 349

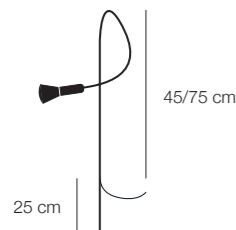

**Syphaduepassi** / standing lamp / driver and accessories not incl. (see pages 110-115)

SYD45 / H 45 cm / brass stem and details / grey-transparent cable 225 cm	€	245,00
SYD75 / H 75 cm / brass stem and details / grey-transparent cable 195 cm	€	255,00

voltage	source	type	watt	lumen	K	CRI	en. class	driver/transformer	dimming
-	12V DC LED bulb	G4 bulb (IP65 lampholder)*	1x0,8W	67	2700	80	F	not included available on request	-

## Fil de Fer (outdoor)

[ *Finishes* ] // **Rough iron** (untreated metal) is chosen by the designer specifically because of its uniqueness and its natural ageing property. The appearance of any uneven rust patches does not constitute a defect, since it is a typical sign of the ageing process, which might be considerably accelerated in conditions of high humidity or direct exposure to outdoor weathering.

[ *Cables* ] // ( **s** ) suspension cable. / ( **el** ) electrical cable.

[ *Note* ] // The **lumen** value refers to the rated lumen output of the light source; for the lamp's output please refer to our bim files (see website). / ( \* ) The drivers for the dimmable version of our outdoor products are larger than their not-dimmable standards. They are available on request with custom sized bases and boxes (see our website for further references). / ( \*\* ) IP specifics: lampholder IP65 (not protected against immersion); wires and connectors IP68; drivers IP67; IP average rate of the lamp 65.

p. 353

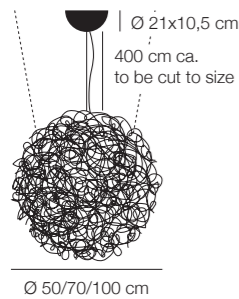

### Fil de Fer / outdoor pendant lamp

		voltage	source	type	watt	lumen	K	CRI	en. class	driver/transformer	dimmer
F5SIPL / Ø 50 cm / aluminium / steel cables <sup>(s)</sup> / metal braided cable <sup>(el)</sup> / chrome base	€ 1.845,00	110V or 240V	12V DC LED bulb	G4 bulbs (IP65 lampholder)**	8x0,8W 6,4W	552	2700	80	G	electronic 12V DC IP67	NO
F7SIPL / Ø 70 cm / aluminium / steel cables <sup>(s)</sup> / metal braided cable <sup>(el)</sup> / chrome base	€ 2.525,00				16x0,8W 12,8W	1104					
F10SIPL / Ø 100 cm / aluminium / steel cables <sup>(s)</sup> / metal braided cable <sup>(el)</sup> / chrome base	€ 3.425,00				20x0,8W 16W	1380					

weight: Ø 50 8,5 kg / Ø 70 13 kg / Ø 100 18 kg

p. 354

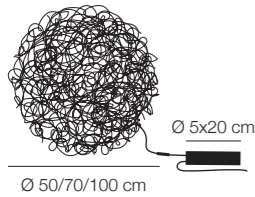

### Fil de Fer F / outdoor floor lamp

		voltage	source	type	watt	lumen	K	CRI	en. class	driver/transformer	dimmer
F5IPL / Ø 50 cm / aluminium / metal braided cable / black box and plug cable	€ 1.650,00	240V (110V available on request)	12V DC LED bulb	G4 bulbs (IP65 lampholder)**	8x0,8W 6,4W	552	2700	80	G	electronic 12V DC IP67	NO
F7IPL / Ø 70 cm / aluminium / metal braided cable / black box and plug cable	€ 2.335,00				16x0,8W 12,8W	1104					
F10IPL / Ø 100 cm / aluminium / metal braided cable / black box and plug cable	€ 3.245,00				20x0,8W 16W	1380					

cable 12V 350 cm / cable 230V 200 cm (with EU or CH plug / UK plug with 300 cm extra)

p. 359

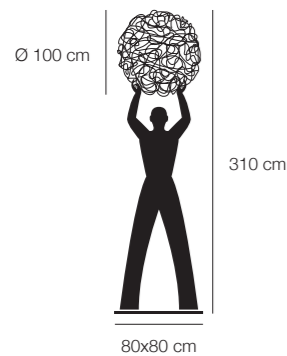

### Uomo della Luce XXL / outdoor standing lamp

		voltage	source	type	watt	lumen	K	CRI	en. class	driver/transformer	dimmer
UIPL / rough iron structure / aluminium sphere / black cable, box and plug cable	€ 9.445,00	240V (110V av. on request)	12V DC LED bulb	G4 bulbs (IP65 lampholder)**	20x0,8W 16W	1380	2700	80	G	electronic 12V DC IP67	NO

cable 12V 350 cm  
cable 230V (EU or CH or UK) 200 cm

## Limited edition

[ Finishes ] // **Untreated brass** (an alloy of copper and zinc) is a very elegant finish, yellow-gold in colour, with an excellent corrosion resistance. It may oxidise, therefore regular cleaning helps preserving its original appearance and slow down the ageing process, which might be anyway accelerated by the weather, frequent handling or conditions of high humidity.

[ Note ] // The **lumen** value refers to the rated lumen output of the light source; for the lamp's output please refer to our bim files (see website).

p. 365

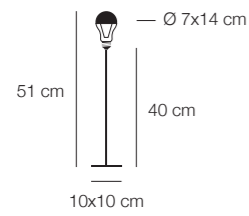

**Trenta** / battery table lamp / plug driver 110-240V with EU plug

TRENTA / glass bulb / brass-coated cover / 1x1W LED / on/off included

€ 1.550,00

	voltage	source	type	watt	lumen	K	CRI	en. class	driver/transformer	dimmer
TRENTA / glass bulb / brass-coated cover / 1x1W LED / on/off included	Li-ION 3,7V 1180 mAh	constant voltage	LED	1x1W	100	2700	80	A+	input 110/240V output 5V@1,2 A (EU or UK plug only)	NO on/off switch included



**LEDERAM: COLOUR COMBINATIONS AND DETAILS**

**TECHNICAL INFORMATION**

Lederam Manta S1 / S2 / CWS1 / C150 / C180

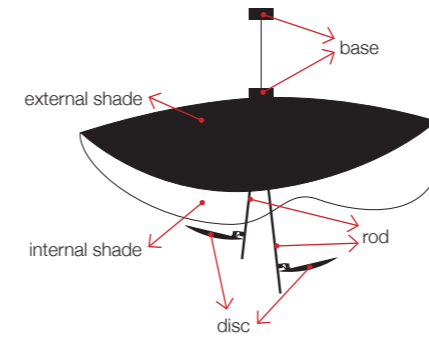

code	shade		rods	discs	base
	external	internal			
3	black	gold	black	gold	black
4	black	copper	black	copper	black
5	white	white	gold	white	white
6	white	gold	satin	white	white
8	white	white	satin	white	white
10*	white	white	white	white	white

\* Finish not available for model Lederam Manta S2

Lederam C2 / W2

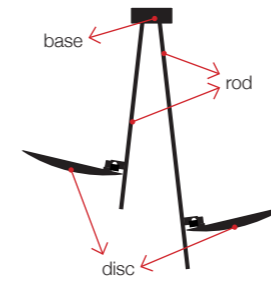

code	discs	rods	base
2	black	satin	black
3	gold	black	black
4	copper	black	black
5	white	gold	white
6	white	satin	white

Lederam W

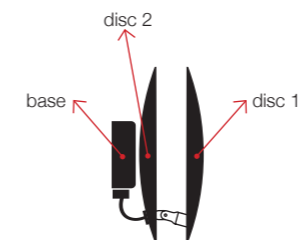

code	disc 1		disc 2		base
	external	internal	internal	external	
1	black	copper	copper	black	black
2	black	gold	gold	black	black
3	gold	gold	gold	white	white
4	copper	copper	copper	white	white
5	white	gold	gold	white	white
6	white	copper	copper	white	white

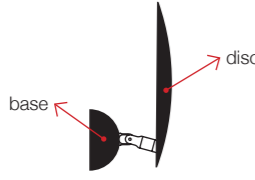

Lederam W1	code	disc		joint	base
		external	internal		
	1	black	black	nickel	black
	3	gold	black	nickel	black
	4	copper	black	nickel	black
	6	white	white	nickel	white



Lederam F0	code	discs	rods	base	cable	dimmer
	2	black	satin	black	black	black
	3	gold	black	black	black	black
	4	copper	black	black	black	black
	6	white	satin	white	white	white
	12	brass	black	black	black	black

Lederam WF	code	disc		base
		external	external	
	1	black	black	black
	3	gold	white	white
	4	copper	white	white
	6	white	white	white

Lederam T1	code	discs	rods	base	cable	dimmer
	2	black	satin	black	black	black
	3	gold	black	black	black	black
	4	copper	black	black	black	black
	5	white	gold	white	blue	black
	6	white	satin	white	blue	black

Lederam F1 / F2 / F3	code	discs	rods	base	cable	dimmer
	2	black	satin	black	black	black
	3	gold	black	black	black	black
	4	copper	black	black	black	black
	5	white	gold	white	white	white
	6	white	satin	white	white	white



## MAINS VOLTAGE LED

The LED modules and COB LED we supply in the Lederam (exception made for Lederam F0) and Medousê collection can be connected directly to the mains voltage because they do not require any driver (other than the one already mounted on the module). Compared to traditional light sources, mains voltage LED modules are more sensitive to any interference in the electricity mains, including voltage fluctuation and harmonic distortion, because they have a faster response to changes in voltage.

This means that consequently to this variations occasional flickering or functioning anomaly may occur, but since not depending on the product, they cannot be considered a flaw or defect.

Further than by problems on the line voltage, fluctuations and harmonics may be produced by variable power loads, as those caused by many types of motors and electronic devices. In case of anomalies we suggest to check the electrical system to apply protective modules reducing overvoltage at the connection terminals of electronic components. By means of this modules / filters, any residual voltage is then reduced to an appropriate protective level in relation to the discharge current.

### Dimming

Mains voltage LED modules and COB LED are dimmable using IGBT (trailing edge) dimmers designed specifically for LED sources. Their dimming is extremely delicate: incompatible dimmers may cause irreparable damage to the LED.

Some dimmers on the market have a NO button (Normally Open button) or they are specific connector socket-mounted or recessed. They are generally inserted into junction boxes; their limited thickness facilitates the installer's task and makes the dimmer fit for installation even in shallow boxes.

Dimmers with an integrated radio dimmer for both manual (NO button) and wireless control are also available.

It is important to note that during adjustment (for instance with a cord dimmer) the dimming appears less precise, with some flickering. Furthermore some types of dimmer, even if they have been recommended by the manufacturers themselves, have visible flickering (almost essentially down to a minimum) depending on the mains and on the type of interference present. The problem can be solved by increasing the minimum value setting of the potentiometer on the dimmer.

LED module

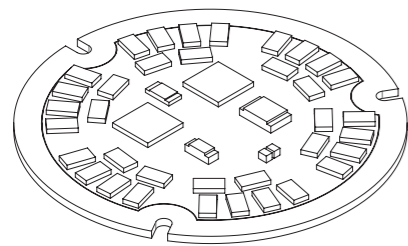

15W  
25W

LED module  
(Medousê)

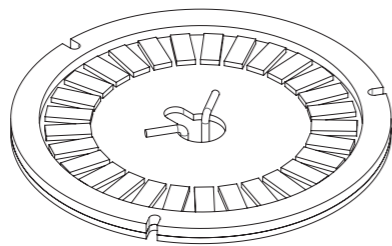

17W  
25W

COB LED

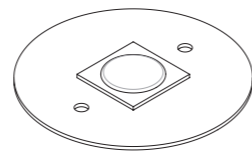

10W  
15W



### NO (Normally Open) Button

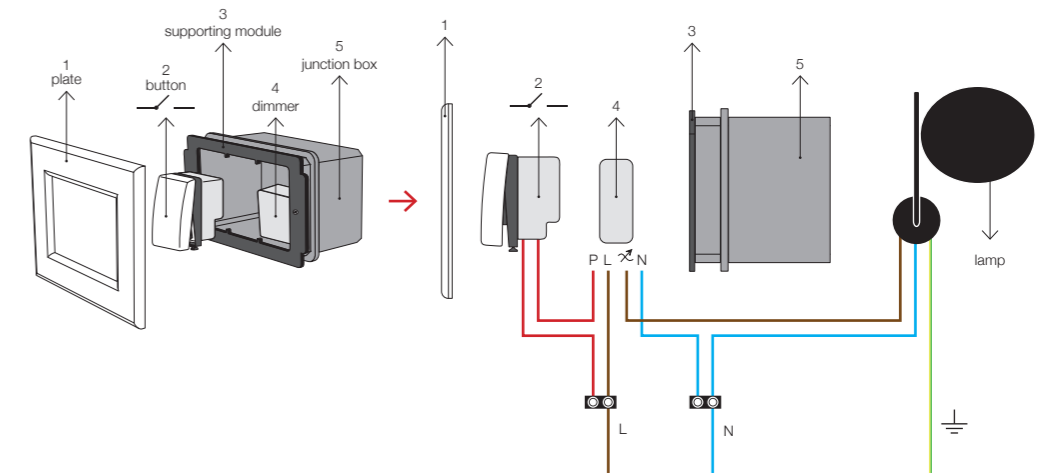

### Socket-mounted or recessed

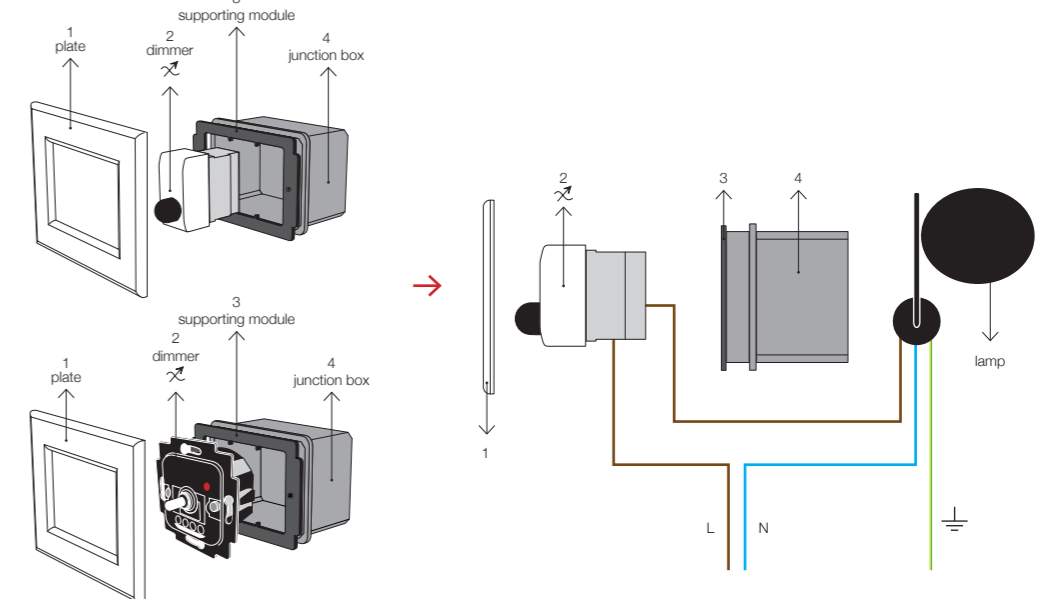

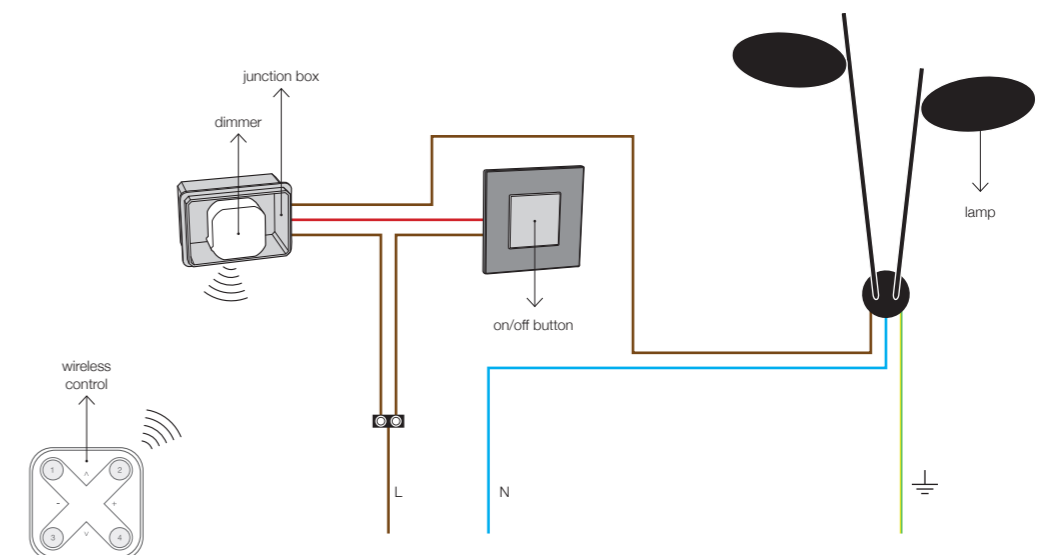

### Wireless



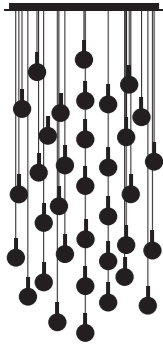
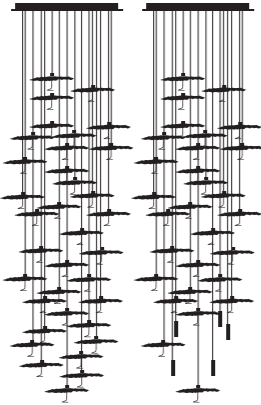
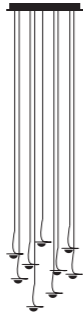

# CHANDELIER

SYPHASPOT	GOLD MOON	JACKIE O	POSTKRISI	SWEET LIGHT
<p>Syphaspot Chandelier is supplied with single pendants with black wires, irregular glass spheres dia. 10 cm with black/brass supports.</p> 	<p>Gold Moon Chandelier is supplied with single pendants with black wires, irregular black/gold shade Ø 20 cm ca. and copper curl directing the beam of light upwards to the shade. Each shade is handmade, therefore the dimensions can slightly change from pendant to pendant. On request it is available also with Spot Light pendants, suggested to add some direct light downwards to the composition.</p> 	<p>Jackie O Chandelier is supplied with single pendant with blue cable and nickel curl with lens, to define the beam of light of each pendant.</p> 	<p>PostKrisi Chandelier is supplied with natural fibreglass spheres with a diameter of 14 or 20 cm. On request it is also available with spheres in different colours or lined with gold/silver/copper coloured leaf.</p> 	<p>Sweet Light Chandelier is supplied with aluminium spheres with a diameter of 10 cm. On request it is also available with brass or silver coloured spheres.</p> 
<b>Bases</b>				

The Chandeliers are supplied with satin steel bases in different dimensions.



square  
30x30x5 cm / 60x60x5 cm



rectangular  
150x30x5 cm / 150x60x5 cm / 90x30x5 cm



round  
Ø 40 cm / Ø 78 cm

The bases of the Chandeliers are modular and very easy to install. The satin finish steel plates are anchored to the white painted metal frame by means of suspension chains that facilitate both installation and maintenance. They are then secured in place with square head screws; the nickel cube that covers the screw remains exposed (see drawing). The steel plate is available on request white painted.

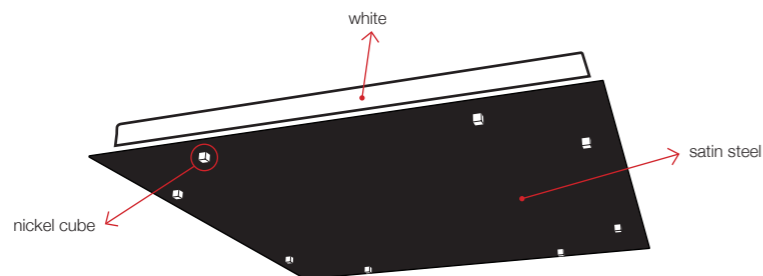

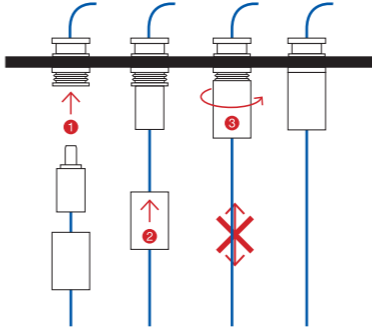
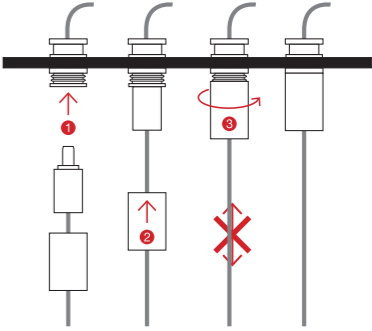
SYPHASPOT	GOLD MOON	JACKIE O	POSTKRISI	SWEET LIGHT
<b>Standard Jack Mounting (NOT ADJUSTABLE HEIGHT)</b>				
<p>Each pendant is mounted onto the base by means of a connection jack that fits in and locks in place in a simple motion. The base can therefore be shipped separately from the pendants, facilitating both the shipping and installation itself.</p>				
<p><b>STANDARD</b></p> <p>The standard maximum height of the codified Jackie O Chandeliers is 120 cm (obtained from H of base 5 cm + max pendant height of 115 cm). Starting from the maximum height, the cable lengths descend 7 times by about 5 cm.</p>  <p><b>ON REQUEST</b></p> <p>By choosing the maximum cable length (up to max 300 cm – dimensions rounded up to the nearest 5 cm) and downsizing while retaining the proportions of the standard codes, a custom made composition can be produced. Any further customisation entails a bespoke design requiring a quotation (customized production).</p>			<p><b>STANDARD</b></p> <p>The standard maximum heights of the codified PostKrisi and Sweet Light Chandeliers are 180/300/400 cm (obtained from H of base 5 cm + max pendant height of 175/295/395 cm).</p>  <p><b>ON REQUEST</b></p> <p>By choosing the maximum cable length (up to max 300 cm – dimensions rounded up to the nearest 5 cm) and downsizing while retaining the proportions of the standard codes, a custom made composition can be produced. Any further customisation entails a bespoke design requiring a quotation (customized production).</p>	
<p><b>NB Each capillary is manually bent. A tolerance of about 1 to 2 cm on the given cables lengths must be considered as acceptable</b></p>				

## On Request (ADJUSTABLE HEIGHT)

**TENSIONER**

The version with a tensioner is available in those cases where the length of the cable requires adjustment during installation. The tensioner is supplied disassembled. Once you have placed the cable at the desired height, it must be cut and reconnected to the inside of the base (this operation helps preventing voltage drops and tangled cables inside the base).

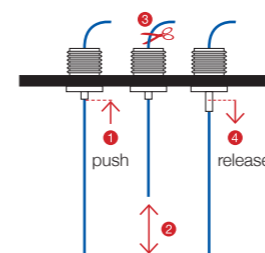

**CABLE LOCKING**

The version with cable locking is available in those cases where the length of the cable requires adjustment during installation or in case of custom chandelier with bigger PostKrisi spheres (dia. 40 or 60 cm). The cable locking is supplied disassembled. Once you have placed the cable at the desired height, it must be cut and reconnected to the inside of the base (this operation helps preventing voltage drops and tangled cables inside the base).

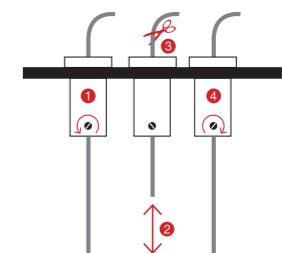

## Custom

On request we can supply customized designs with different base dimensions, a different number of pendants or with a tensioner instead of a jack connection. The PostKrisi and Sweet Light pendants are interchangeable on the bases, therefore we can also supply mixed Chandeliers.





### MACCHINA DELLA LUCE LED BOARDS

12W

18W

24W

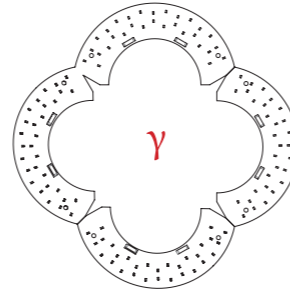
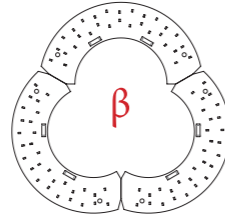
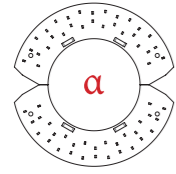

2 x  
LED board 6W 24V DC

3 x  
LED board 6W 24V DC

4 x  
LED board 6W 24V DC

<b>Mod. A</b>		<b>Mod. E</b>	
18W β	Ø 80 cm	12W α	Ø 50 cm
12W α	Ø 30 cm	12W α	Ø 30 cm
12W α	Ø 18 cm		Ø 18 cm
42W	4410 lumen	24W	2520 lumen
<b>Mod. B</b>		<b>Mod. F**</b>	
12W α	Ø 80 cm	24W γ	Ø 120 cm
	Ø 18 cm	18W β	Ø 80 cm
		12W α	Ø 50 cm
12W	1260 lumen		Ø 30 cm
54W	5670 lumen		
<b>Mod. C</b>		<b>Mod. I</b>	
24W γ	Ø 120 cm	18W β	Ø 80 cm
18W β	Ø 80 cm	12W α	Ø 50 cm
	Ø 50 cm		Ø 30 cm
42W	4410 lumen	30W	3150 lumen
<b>Mod. D*</b>			
18W β	Ø 120 cm		
18W β	Ø 80 cm		
12W α	Ø 50 cm		
12W α	Ø 30 cm		
12W α	Ø 18 cm		
60W	6300 lumen		

\* 110V version available with 4x α 12W / tot. 48W max

\*\* 110V version available with 2x β 18W / 1x α 12W / tot. 48W max



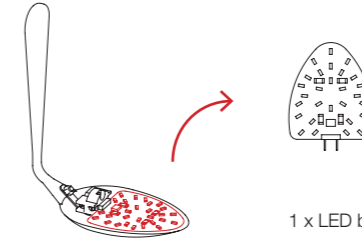

### STCHU-MOON LED BOARDS





1 x LED board GY6.35 3,9W 24V DC

1x 3,9W / 420 lumen			Stchu-Moon 05
			Stchu-Moon 01 Ø 40 cm
			Stchu-Moon 01 Ø 60 cm
2x 3,9W / 840 lumen			Stchu-Moon 09
			Stchu-Moon 02 Ø 40/60 cm
4x 3,9W / 1680 lumen			Stchu-Moon 02 Ø 80/100 cm
6x 3,9W / 2520 lumen	3x		Stchu-Moon 02 Chandelier

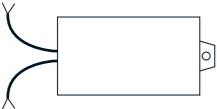
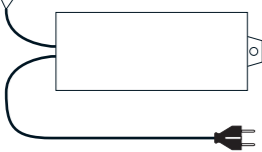
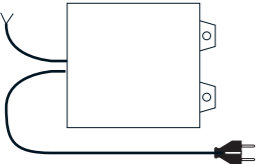
**OUTDOOR: GEL BOX SYSTEM**

	<b>MB1</b> Mini gel box IP68
	5,3x3,9x2,4 cm
	(max 2 connections - connectors included)
	Price IVA / VAT excl. € 35,00
	<b>MB2</b> Mini gel box IP68
	5,2x5,3x2,9 cm
	(max 6 connections - connectors included)
	Price IVA / VAT excl. € 35,00
	<b>KP1</b> Extension cord kit
	5 mt
	with mini gel box IP68 for single connection
	(max 1 lamp) Price IVA / VAT excl. € 55,00
	<b>ED6</b> Driver 10W 12V DC 220-240V IP67
	7x3,7x2,3 cm / cables 45 cm ca.
	not dimmable
	(max 9 lamps) Price IVA / VAT excl. € 80,00
	<b>ED7</b> Driver 30W 12V DC 220-240V IP67
	11x3,7x2,3 cm / cable 12V 45 cm ca. / plug cable 200 cm
	not dimmable
	(max 28 lamps)
	<b>ED7D</b> Driver 30W 12V DC 220-240V IP67
	8x8x3 cm / cables 12V 45 cm ca. / plug cable 200 cm
	Triac dimmable
	(min. 12 max 28 lamps)

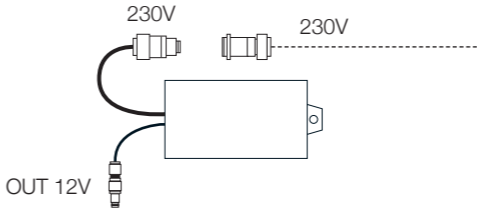
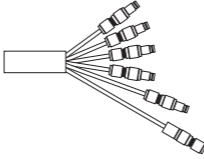
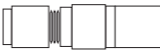
**OUTDOOR: QUICK CONNECTORS SYSTEM**

	<b>ED6CR</b> Driver 10W 12V DC 220-240V IP67
	230V and 12V connectors included
	3,7x2,3x7 cm - cables 45 cm ca.
	not dimmable Price IVA / VAT excl. (max 9 lamps) € 120,00
	<b>CRM</b> Quick IP68 multiple connector / 1 IN & 5 OUT 12V
	(max 5 connections)
	Price IVA / VAT excl.
	€ 140,00
	<b>CRS</b> Quick IP68 IN single connector
	(max 1 connections)
	Price IVA / VAT excl.
	€ 40,00
	<b>KP2</b> Extension cord kit with quick IP68 connectors CRS
	5 mt
	(max 1 lamp) Price IVA / VAT excl.
	€ 90,00

**OUTDOOR: FIL DE FER**

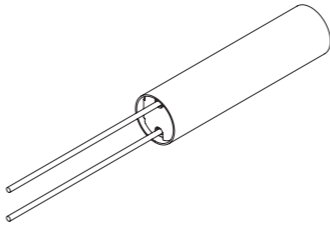
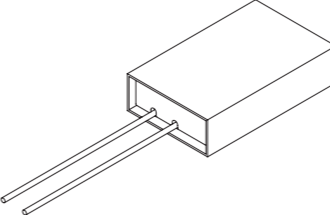
	<b>FKIPL</b> Kit box driver
	Ø 5x20 cm / cable 12V 45 cm / plug cable 200 cm
	not dimmable (driver ED7)
	standard
	<b>FKIPLD</b> Kit box driver
	16x10x4 cm / cable 12V 45 cm / plug cable 200 cm
	Triac dimmable (driver ED7D)
	available on request



## OUTDOOR ACCESSORIES

	<b>MSMP</b> Supporting modular plate
	for More (MR70/MR100/MR130)
	32x32x32 cm
	(max 3 lamps)
	Price IVA / VAT excl.
	€ 80,00
	<b>MPT</b> Peg
	for More (MR70/MR100/MR130)
	25 cm
	Price IVA / VAT excl.
	€ 30,00
	<b>MSM</b> Supporting plate
	for Medousê F
	31x31 cm ca.
	Price IVA / VAT excl.
	€ 85,00
	<b>MDCV</b> Plug cable 230V standard EU (CH or UK available on request)
	for Medousê F
	350 cm
	Price IVA / VAT excl.
	€ 40,00



## MEDOUSÊ INSTALLATION SUGGESTIONS

### WARNING

For stability reasons the lamp must be fastened to a solid surface such as a well or basement; in alternative it can be mounted on the modular supporting plate (code MSM) available on request. Before installing the lamp, please check the levelling of the soil and make sure that it can support the weight of the fitting.

(Medousê weight Ø 30 cm 15 kg / Ø 50 cm 31 kg)

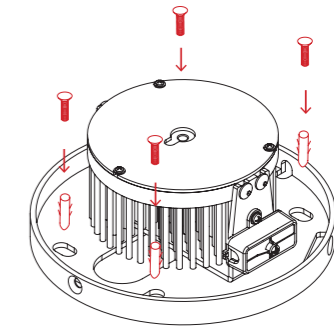

lamp base with holes for the fastening  
(plugs not included)

### Example 1

with basement and supply cable from the side

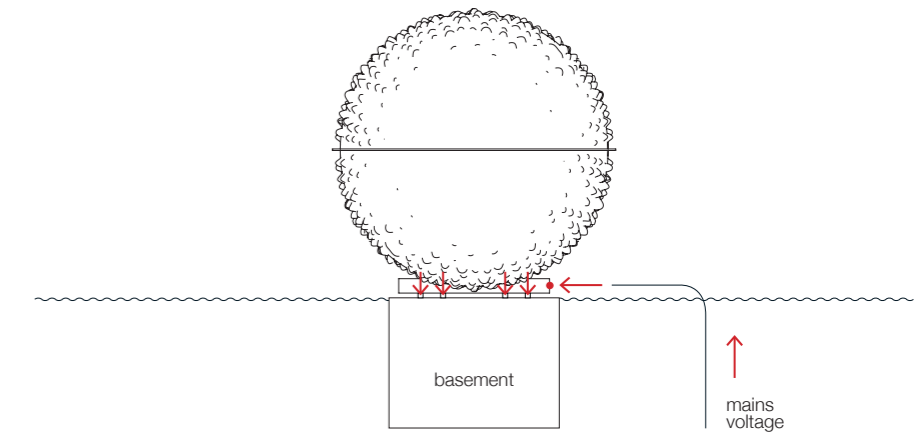
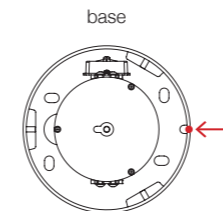

### Example 2

with well and supply cable from underneath

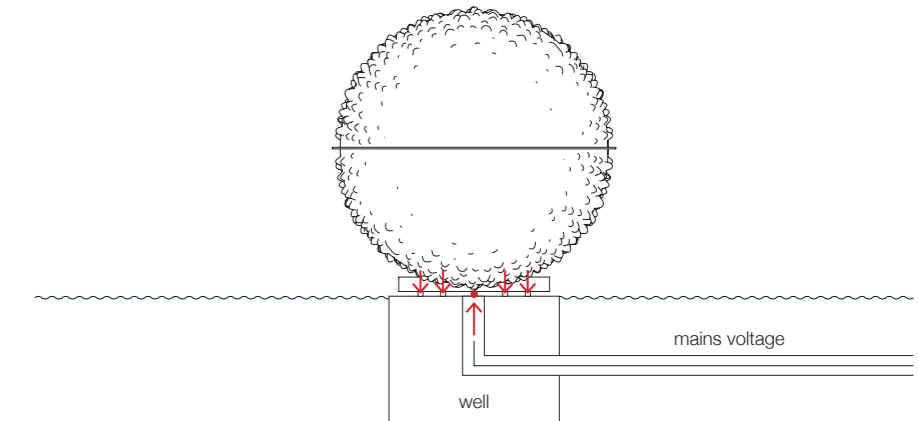
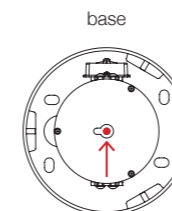

### Example 3

with supporting plate 1x code MSM  
with plug cable 230V 1x code MDCV

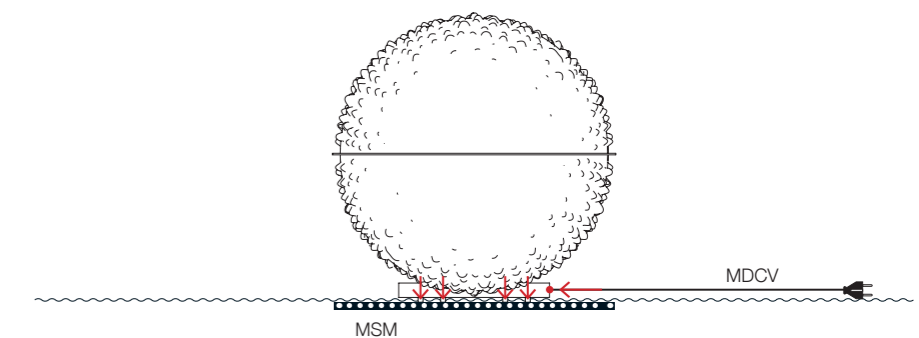
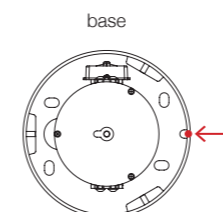

**Installation suggestions for Outdoor / GEL BOX system**

1	Connection type	For models	Power supply	Access. applied
	GEL BOX system (without well)	Syphasera/Syphasfera/Syphaduepassi/More	code ED6	1x code ED6 1x code MB1 1x code MB2

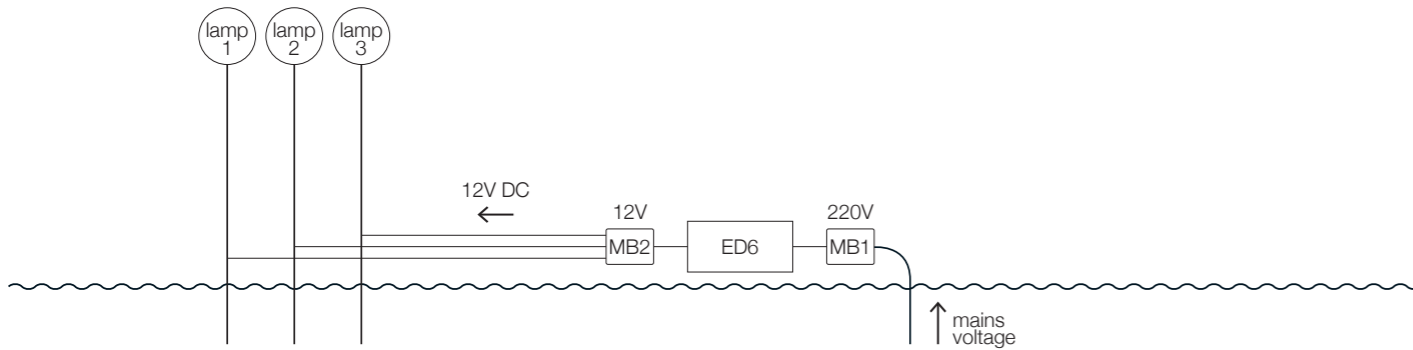

2	Connection type	For models	Power supply	Access. applied
	GEL BOX system (with well)	Syphasera/Syphasfera/Syphaduepassi/More	provided by client	1x code MB2 1x code KP1

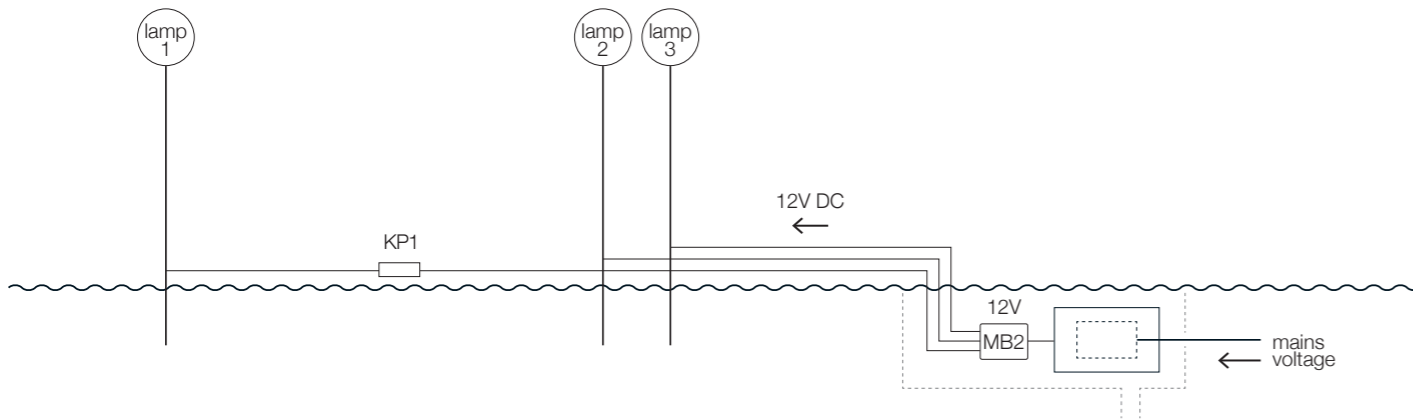

3	Connection type	For models	Power supply	Access. applied
	GEL BOX system (without well)	More (MR70/MR100/MR130)	code ED6	1x code ED6 1x code MB1 1x code MB2 1x code MSMP 3x code MPT*

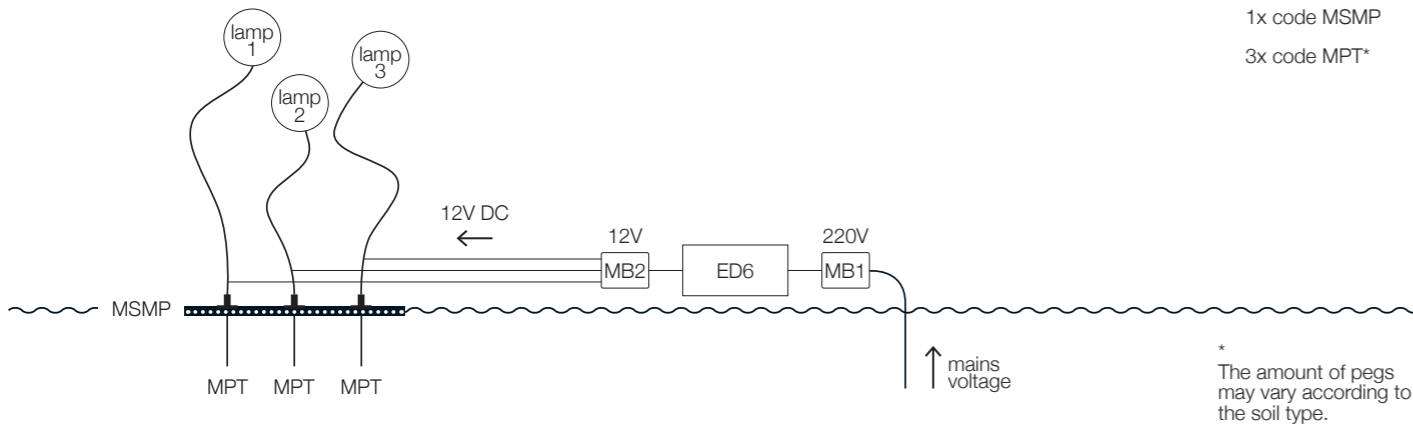

\* The amount of pegs may vary according to the soil type.

4	Connection type	For models	Power supply	Access. applied
	GEL BOX system (with well)	More (MR70/MR100/MR130)	provided by client	1x code MB2 1x code MSPT 3x code MPT

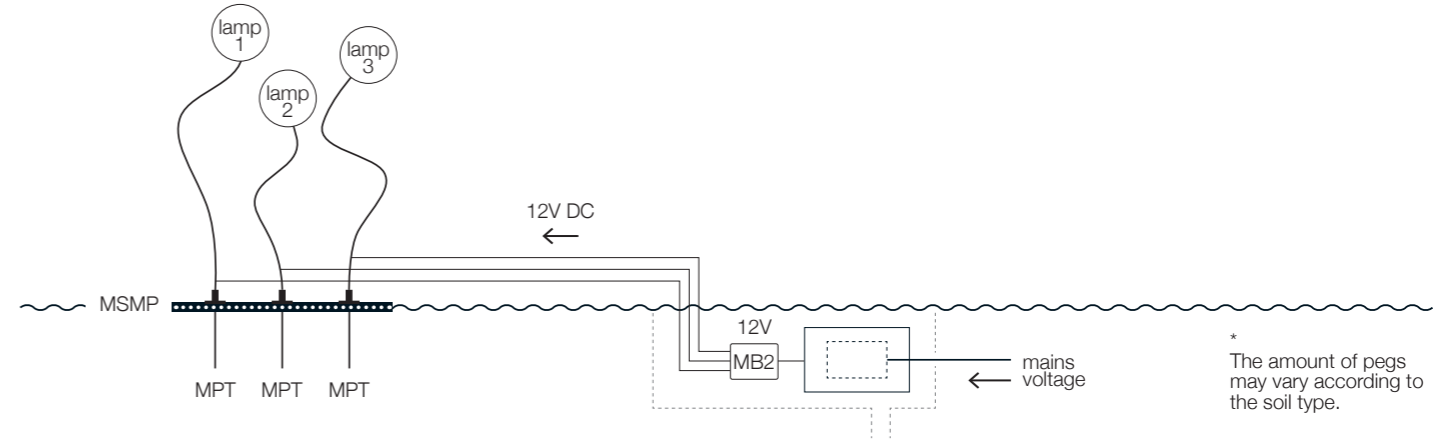

\* The amount of pegs may vary according to the soil type.

5	Connection type	For models	Power supply	Access. applied
	QUICK CONNECTORS system	Syphasera/Syphasfera/Syphaduepassi/More	code ED6CR	1x code ED6CR 1x code CRM 5x code CRS 1x code KP2

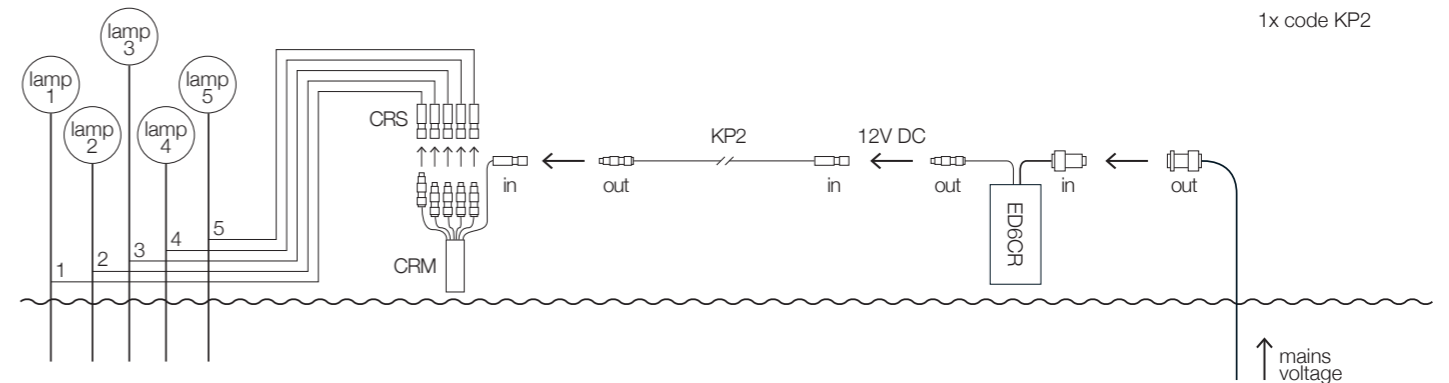

6	Connection type	For models	Power supply	Access. applied
	QUICK CONNECTORS system	Syphasera/Syphasfera/Syphaduepassi/More		2x code CRM 9x code CRS

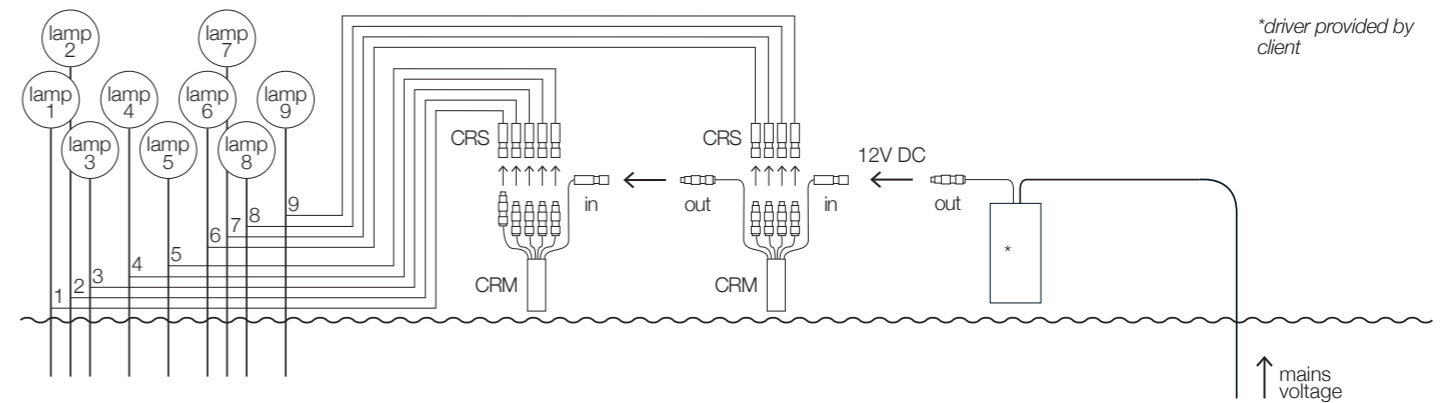

\* driver provided by client

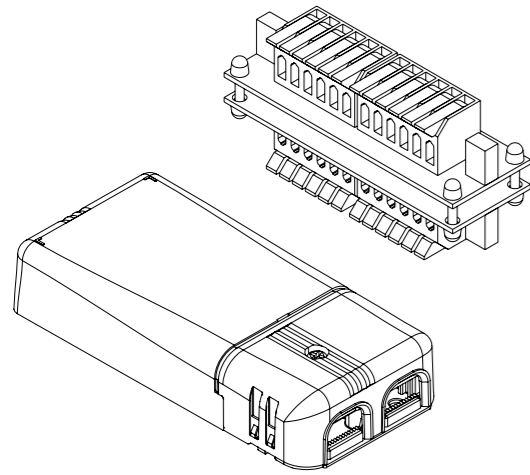
**PSU (POWER SUPPLY UNIT) KITS FOR JACKIE O/GOLD MOON/SYPHASPOT/SPOTLIGHT IC-JC**

By means of the PSU kit, multiple LED lamps can be controlled simultaneously through a connection board connected to a driver.  
 The basic board can connect up to 12 lamps; we can combine 2 boards to connect up to 24 lamps.  
 It is advisable to install the kit in a technical compartment at a maximum distance of about 5 meters from the point of installation of the jacks or tensioners, in order to avoid voltage drops.  
 The technical compartment must be located in an easily accessible place and large enough to accommodate both the wired multiple connection board and the power supply.

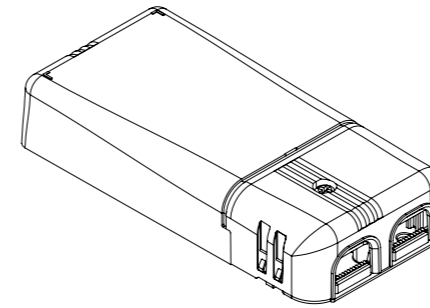
**DRIVERS @24V DC FOR PEPITA 65 / PEPITA 102 / JACKIE O / GOLD MOON / SYPHASPOT / SPOTLIGHT**

By means of the driver, multiple LED lamps can be controlled simultaneously. In the event of a failure of even a single lamp, the other lamps continue working properly.  
 It is advisable to install the driver in a technical compartment accessible for inspection at a maximum distance of about 5 meters from the point of installation of the lamps, in order to avoid voltage drops.  
 The technical compartment must be located in an easily accessible place and large enough to accommodate the power supply.

PSU KITS		Price IVA / VAT excl.
<b>K9WS12</b>	<b>20W driver kit 220-240V (with ED9)</b>	
	lamps quantity: min 3 / max 12 x1,1W or min 3 / max 12 x1,2W	€ 90,00 (net price)
	Triac dimmable	
	driver dimensions 11x5,2x2,2 cm	
<b>K10WS12</b>	<b>20W driver kit 110-240V (with ED10)</b>	
	lamps quantity @240V: min 2 / max 12 x1,1W or min 2 / max 12 x1,2W lamps quantity @110V: min 2 / max 12 x1,1W or min 2 / max 11 x1,2W	€ 105,00 (net price)
	1...10V or PUSH dimmable	
	driver dimensions 11x5,2x2,2 cm	
<b>K11WS12</b>	<b>20W driver kit 110-240V (with ED11)</b>	
	lamps quantity @240V: min 2 / max 12 x1,1W or min 2 / max 12 x1,2W lamps quantity @110V: min 2 / max 12 x1,1W or min 2 / max 12 x1,2W	€ 110,00 (net price)
	DALI dimmable	
	driver dimensions 11x5,2x2,2 cm	
<b>K12WS24</b>	<b>30W driver kit 220-240V (with ED12)</b>	
	lamps quantity: min 13 / max 24 x1,1W or min 13 / max 22 x1,2W	€ 160,00 (net price)
	Triac dimmable	
	driver dimensions 18x6x3,5 cm	
<b>K13WS24</b>	<b>36W driver kit 110-240V (with ED13)</b>	
	lamps quantity @240V: min 13 / max 24 x1,1W or min 13 / max 24 x1,2W lamps quantity @110V: min 13 / max 24 x1,1W or min 13 / max 22 x1,2W	€ 160,00 (net price)
	DALI or PUSH dimmable	
	driver dimensions 16,5x4,1x3,5 cm	

DRIVERS @24V DC		Price IVA / VAT excl.
<b>ED9</b>	rated voltage 220-240V	
	rated output 20W lamps quantity: min 3 / max 13 x1,1W or min 3 / max 12 x1,2W	€ 40,00 (net price)
	Triac dimmable	
	dimensions 11x5,2x2,2 cm	
<b>ED11</b>	rated voltage 110-240V	
	rated output 15W @110V // lamps quantity: min 2 / max 12 x1,1W or min 2 / max 11 x1,2W rated output 16W @240V // lamps quantity: min 2 / max 12 x1,1W or min 2 / max 11 x1,2W	€ 60,00 (net price)
	DALI dimmable	
	dimensions 11x5,2x2,2 cm	
<b>ED14</b>	rated voltage 110-240V	
	rated output 4W lamps quantity: min 1 / max 3 x1,1W or min 1 / max 2 x1,2W	€ 35,00 (net price)
	not dimmable	
	dimensions 4x2,7x2,1 cm	



**INSTRUCTIONS FOR THE CONNECTION OF MULTIPLE LAMPS RECESSED FOR PLASTERBOARD**  
**WALL/CEILING PEPITA 65 / PEPITA 102**

1.

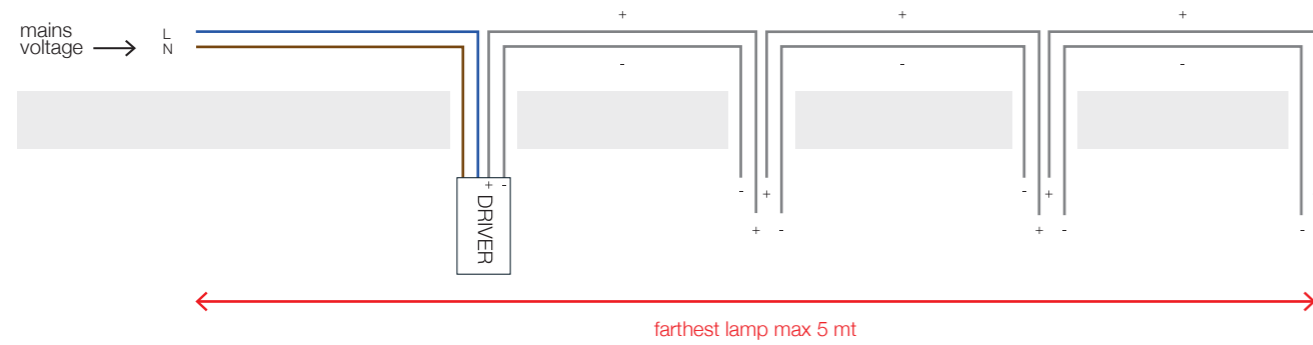

it is recommended to respect the polarity

2.

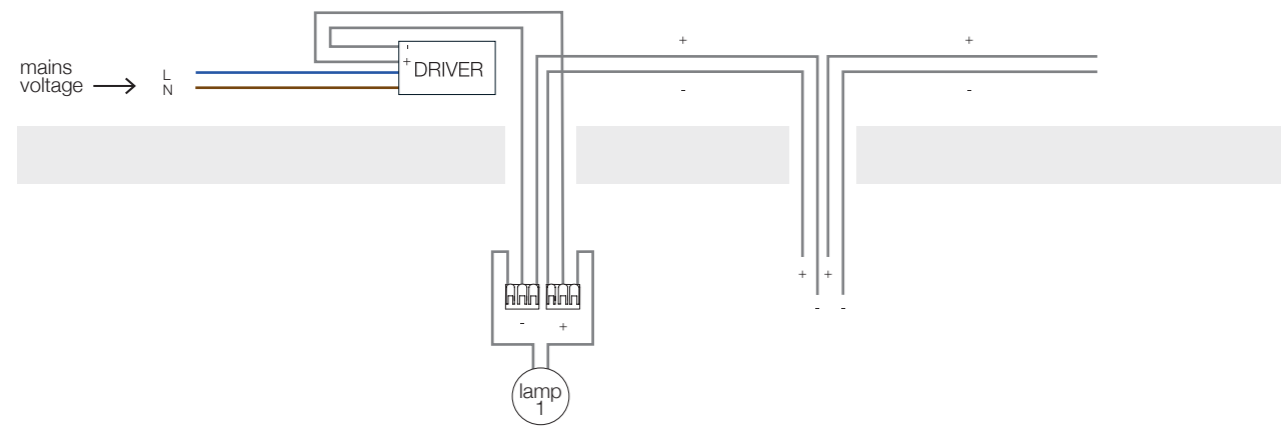

3.

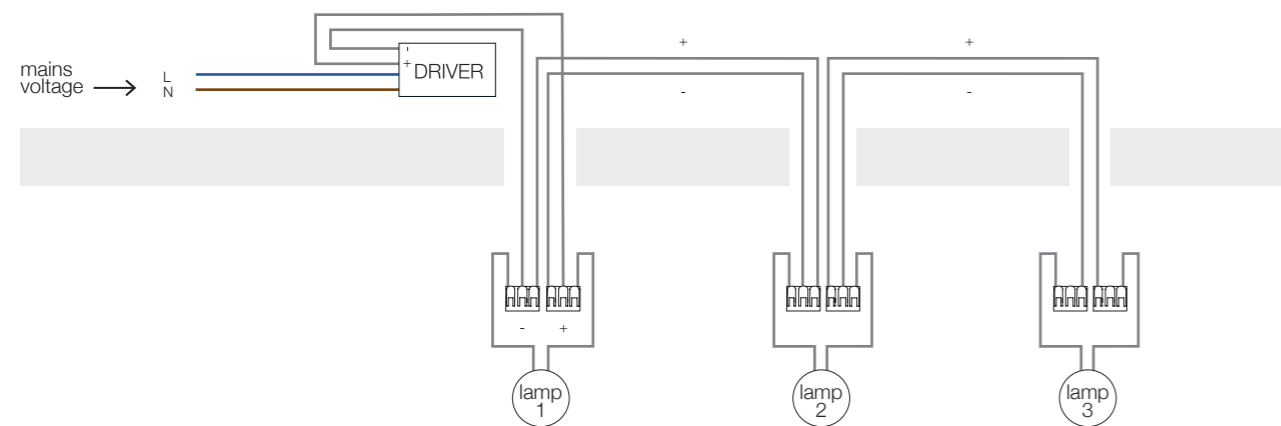

the cable between the lamps is not supplied,  
it is recommended to use one with a minimum section of conductors of 1 mmq



**DIMMING WIRING DIAGRAMS**

**Diagram 1 - IGBT - TRIAC**

1 wire for power supply  
1 wire for dimming

WARNING: Our LEDs can be dimmed by using compatible dimmers tested specifically to dim very low loads. We suggest checking the minimum load of the dimmer before installation.

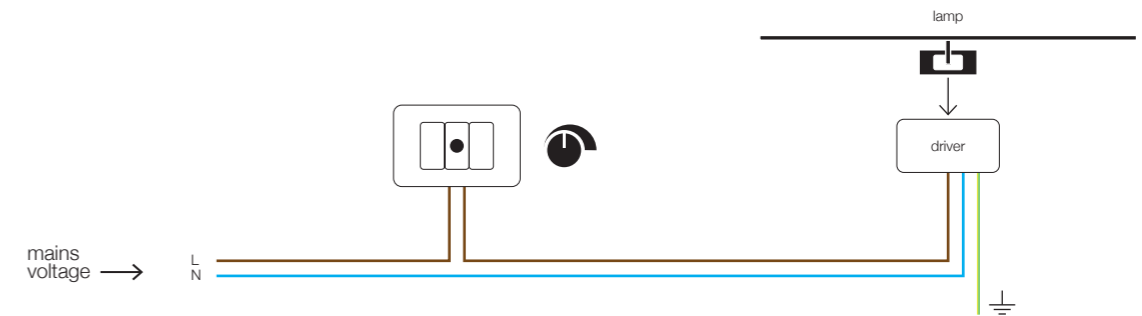

**Diagram 2 - PUSH**

2 wires for power supply  
2 wires for dimming

WARNING: you need two extra wires, marked in red, in order to dim.

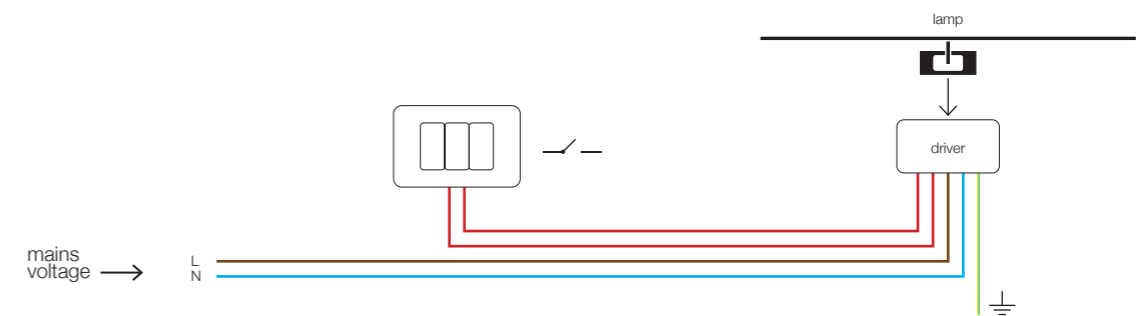

**Diagram 3 - 1...10V - DALI**

2 wires for power supply  
2 wires for dimming

WARNING: you need two extra wires, marked in red, in order to dim.

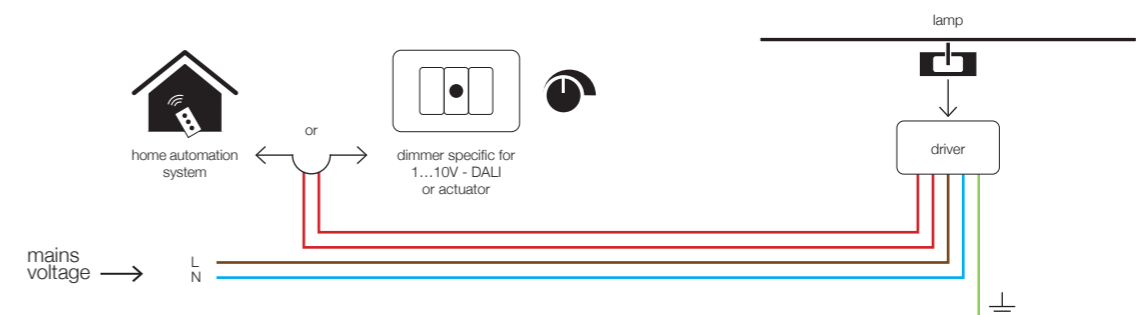

## **Catellani & Smith**

### Offices

via Cimitero 1/A  
I-24020 Villa di Serio, BG  
T. +39 035 656088  
[info@catellanismith.com](mailto:info@catellanismith.com)

### Showrooms

Bergamo  
Via Borfuro, 1 Bergamo  
T. +39 035 210193  
[show-room@catellanismith.com](mailto:show-room@catellanismith.com)

Milano  
Salvioni Milano Durini  
Via Durini, 3 Milano

London  
Ltd. 7-15 Rosebery Ave Clerkenwell  
London EC1R 4SP, U.K.

[www.catellanismith.com](http://www.catellanismith.com)



Catellani & Smith®